



HYUNDAI

Rettungsdatenblätter für Rettungskräfte

Hinweis:

Diese Rettungsdatenblätter wurden ausschließlich für Rettungskräfte erstellt, die über eine spezielle Ausbildung auf dem Gebiet der technischen Hilfeleistung nach Verkehrsunfällen und der damit verbundenen Tätigkeiten verfügen. Ferner enthalten die Rettungsdatenblätter ausschließlich Informationen über Fahrzeuge, die zum Verkauf in Deutschland bestimmt sind.

Spezifikationen und Sonderausstattungen der Hyundai Fahrzeuge sowie das Fahrzeugangebot unterliegen stetig etwaigen Änderungen. Daher behält sich Hyundai inhaltliche Anpassungen bzw. Änderungen an den Rettungsdatenblättern jederzeit ausdrücklich vor.

Die in diesem Leitfaden enthaltenen Informationen sind nicht für Endkunden und ebenfalls nicht für Werkstätten und Händler bestimmt. Endkunden können den Bordbüchern ihres jeweiligen Fahrzeuges detaillierte Informationen zu den Funktionen ihres Fahrzeuges sowie wichtige Sicherheitshinweise zur Fahrzeug- und Insassensicherheit entnehmen. Werkstätten und Händler erhalten Reparaturinformationen über die ihnen bekannten Bezugsquellen.



Rettungsdatenblätter

A

• Accent (3-Türer)	LC	ab 2000
• Accent (5-Türer)	LC	ab 2000
• Accent (3-Türer)	MC	ab 2006
• Accent (4-Türer)	MC	ab 2006
• Atos	MX/MXL/MXI	ab 1998

C

• Coupe	GK	ab 2002
• Coupe	GK	ab 2006

E

• Elantra (4-Türer)	XD	ab 2000
• Elantra (5-Türer)	XD	ab 2000

G

• Genesis Coupe	BK	ab 2011
• Genesis	DH	ab 2014
• Getz (3-Türer)	TB	ab 2002
• Getz (5-Türer)	TB	ab 2002
• Grandeur	TG	ab 2005

H

• H-1	H1	ab 1998
• H-1	H1	ab 2008
• H-350 (Cargo)	EU	ab 2015
• H-350 (Fahrgestell)	EU	ab 2015
• H-350 (Bus)	EU	ab 2016

I

• i10	PA	ab 2008
• i10	PA	ab 2011
• i10	IA	ab 2014
• i20 (3-Türer)	PB	ab 2008
• i20 Coupe	GB	ab 2015
• i20 (5-Türer)	PB	ab 2008
• i20 (5-Türer)	GB	ab 2014
• i30	FD/FDH	ab 2008
• i30	GDH	ab 2012
• i30	PDE	ab 2017
• i30 Coupe	GDH	ab 2013
• i30cw	FD/FDH	ab 2008
• i30cw	GDH	ab 2012
• i30cw	PDE	ab 2017
• i40 (4-Türer)	VF	ab 2012
• i40cw	VF	ab 2011
• ix20 (5-Türer)	JC	ab 2010
• ix35 (5-Türer)	EL	ab 2010
• ix35 FCEV (5-Türer)	LM	ab 2013



Rettungsdatenblätter

I

- | | | |
|----------------------------------|---------|---------|
| • ix55 (5-Türer) | EN | ab 2009 |
| • Ioniq Hybrid (5-Türer) | AE HEV | ab 2016 |
| • Ioniq Elektro (5-Türer) | AE EV | ab 2016 |
| • Ioniq Plug-in Hybrid (5-Türer) | AE PHEV | ab 2017 |

M

- | | | |
|--------------------|--------|---------|
| • Matrix (5-Türer) | FC/FCT | ab 2002 |
|--------------------|--------|---------|

S

- | | | |
|------------------------------|-------|---------|
| • Santa Fe (5-Türer) | SM | ab 2000 |
| • Santa Fe (5-Türer) | CM | ab 2006 |
| • (Grand) Santa Fe (5-Türer) | DM/NC | ab 2012 |
| • Sonata (4-Türer) | EF | ab 1999 |
| • Sonata (4-Türer) | EF | ab 2001 |
| • Sonata (4-Türer) | NF | ab 2005 |

T

- | | | |
|----------------------|-----|---------|
| • Terracan (5-Türer) | HP | ab 2001 |
| • Trajet (5-Türer) | FO | ab 2000 |
| • Tucson (5-Türer) | JM | ab 2004 |
| • Tucson (5-Türer) | TLE | ab 2015 |

V

- | | | |
|----------------------|----|---------|
| • Veloster (4-Türer) | FS | ab 2011 |
|----------------------|----|---------|

X

- | | | |
|----------------|----|---------|
| • XG (4-Türer) | XG | ab 1999 |
|----------------|----|---------|

In den Rettungsdatenblättern ist immer die maximal mögliche Ausstattung des Fahrzeugs angegeben.





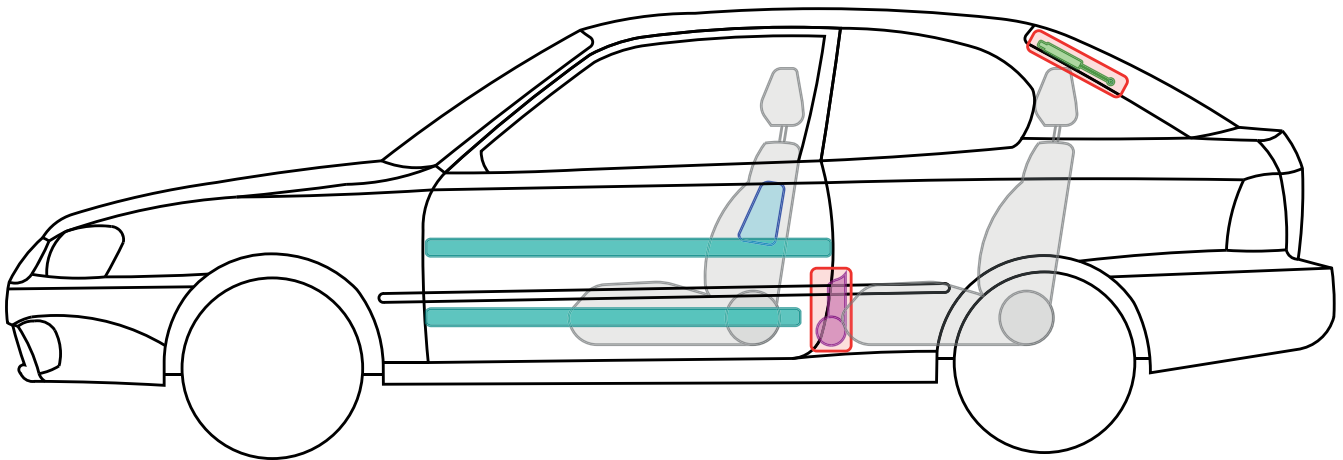
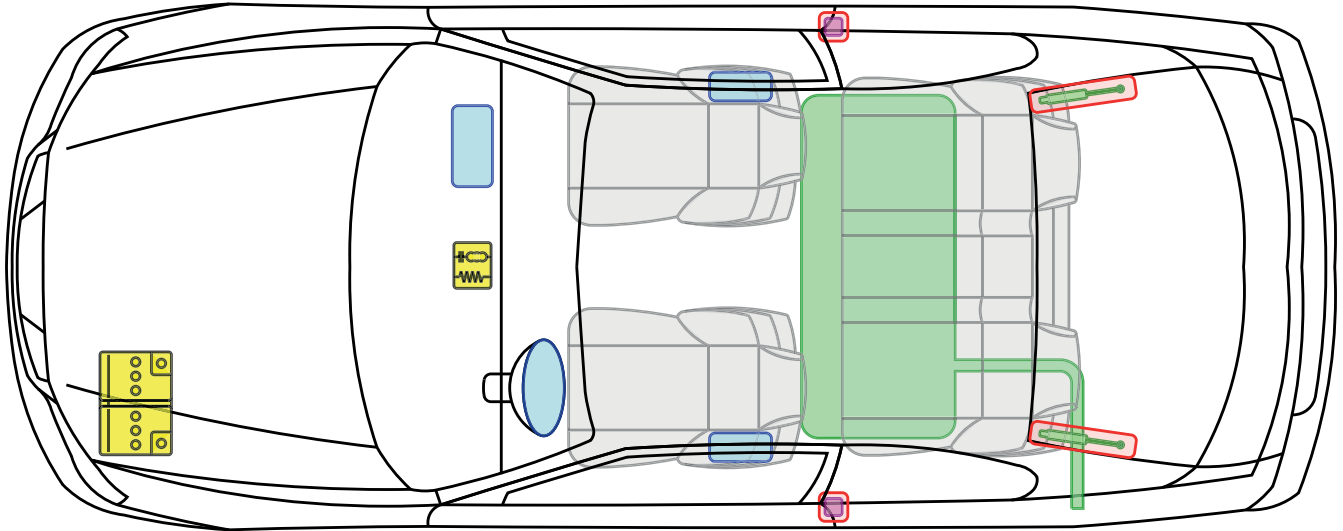

Die Erstellung der Rettungsdatenblätter erfolgte mit freundlicher Unterstützung von Moditech Rescue Solutions B.V (www.moditech.com).

Die gezeigten Fahrzeuggrafiken sind in erweiterter interaktiver Form auch in der Datenbank Crash Recovery System zu finden.

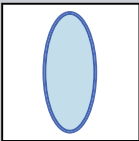
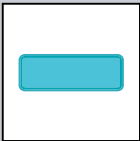

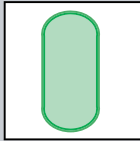
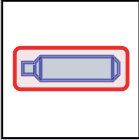
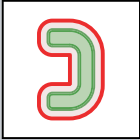
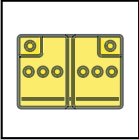

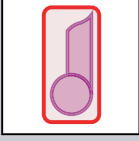
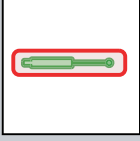
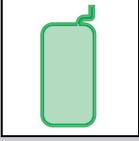

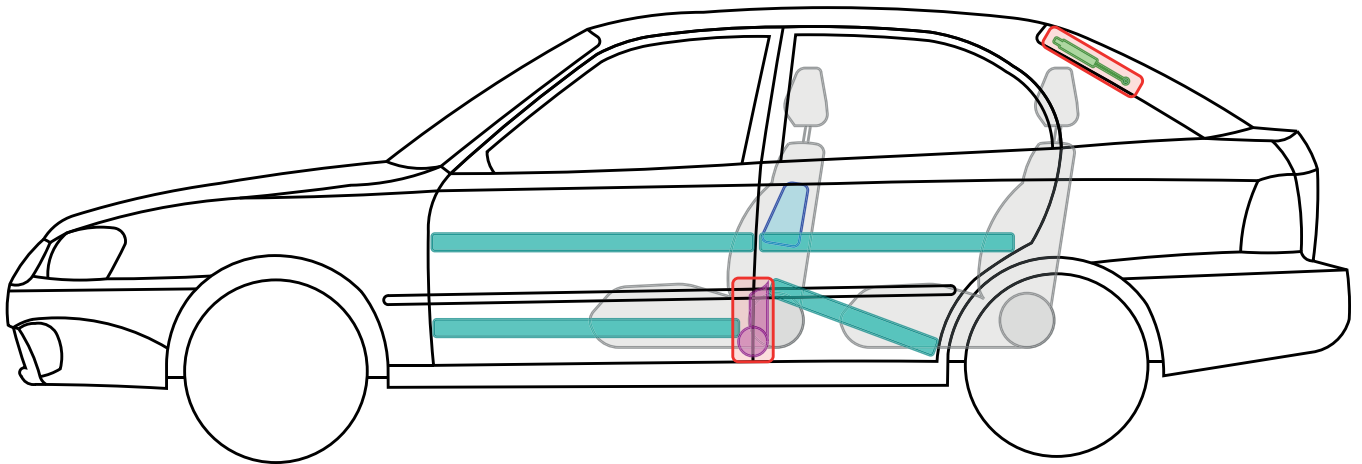
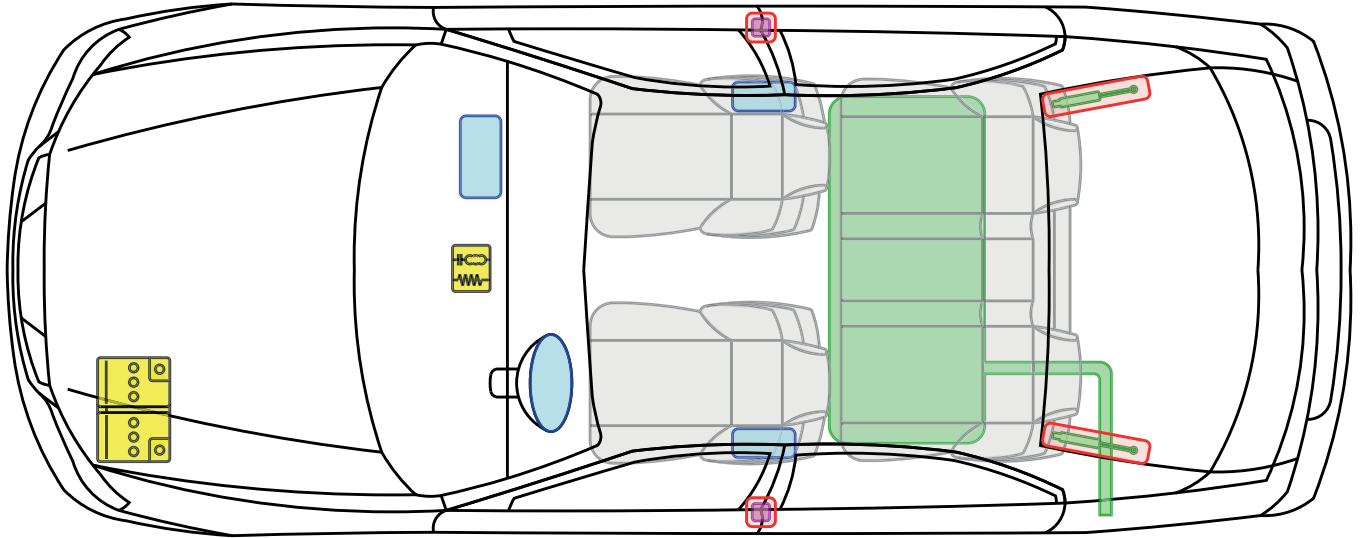

Legende

	Airbag		Karosserie- verstärkung		Steuergerät		Gastank
	Gas- generator		Überroll- schutz		12 V Batterie		Sicherheits- ventil
	Gurt- straffer		Gasdruck- dämpfer		Kraftstoff- tank		

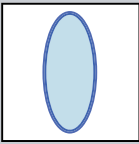
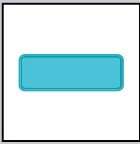
Accent

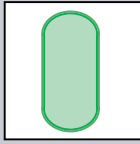
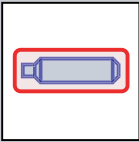
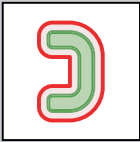
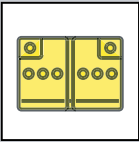

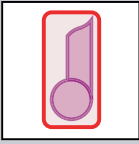
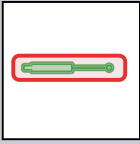

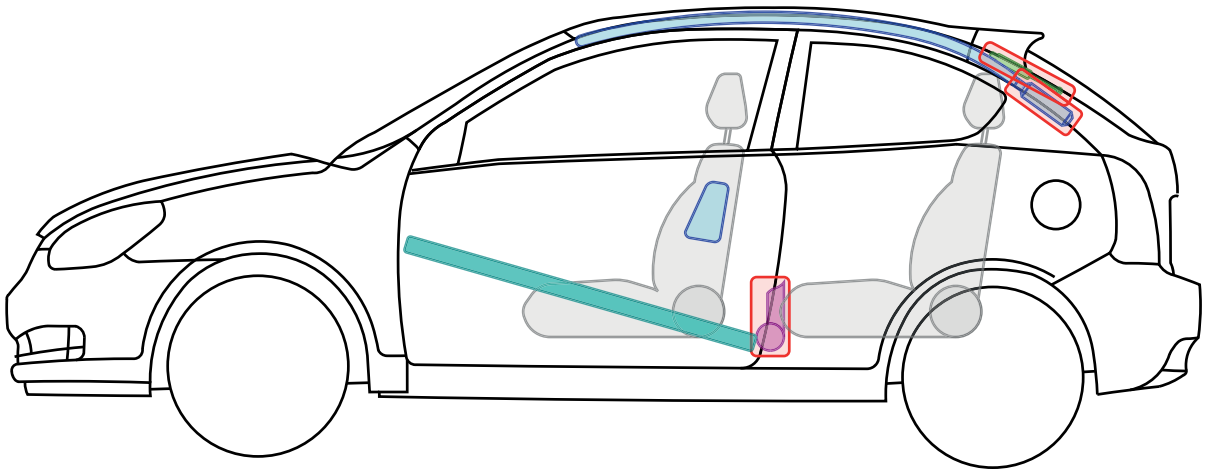
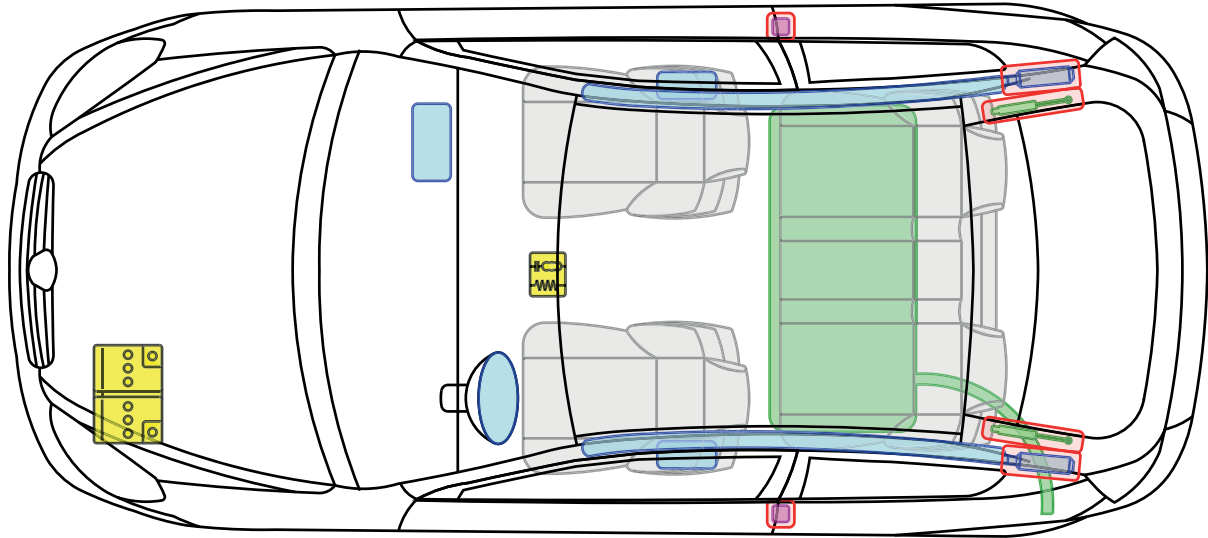

Legende

	Airbag		Karosserie- verstärkung		Steuergerät		Gastank
	Gas- generator		Überroll- schutz		12 V Batterie		Sicherheits- ventil
	Gurt- straffer		Gasdruck- dämpfer		Kraftstoff- tank		

Accent

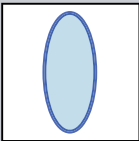
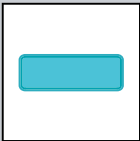

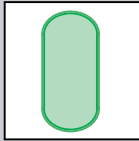
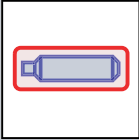
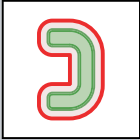
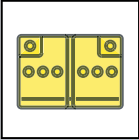

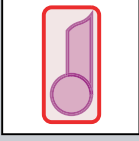
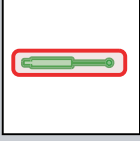
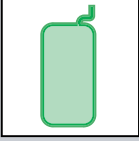

Legende

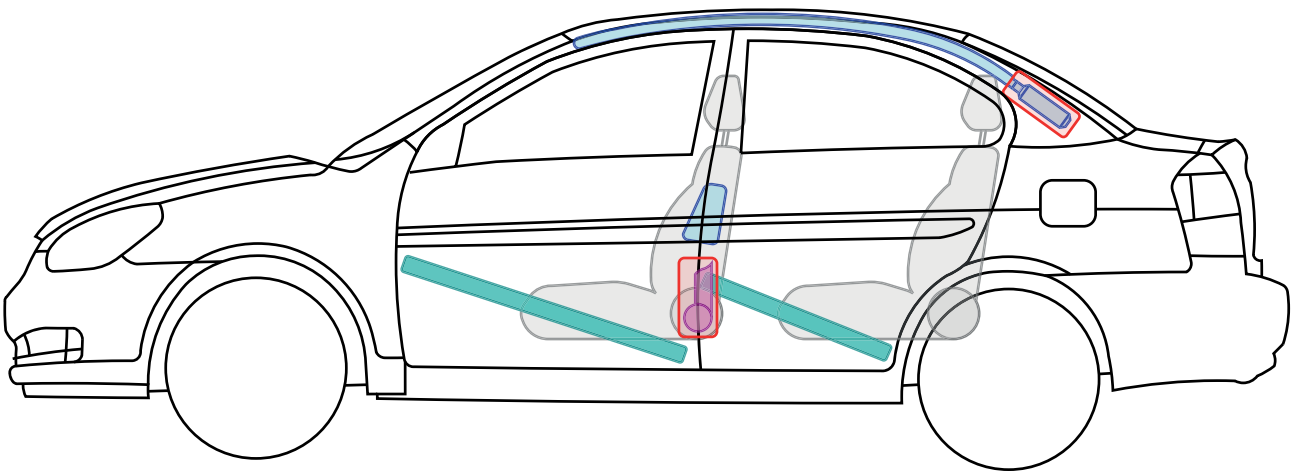
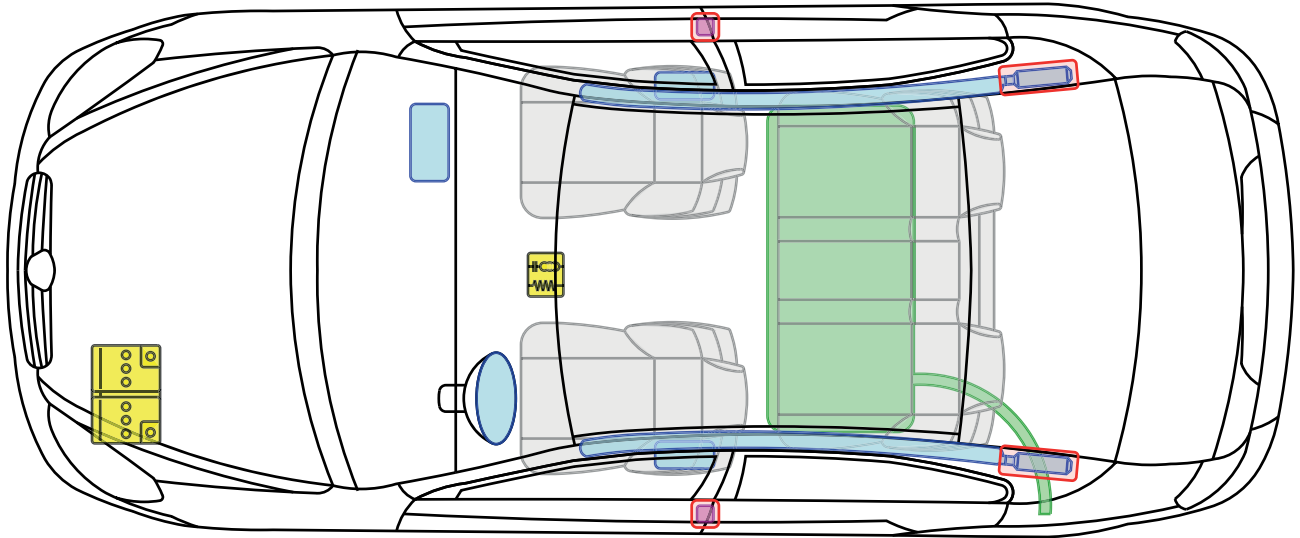
	Airbag		Karosserie- verstärkung		Steuergerät		Gastank
	Gas- generator		Überroll- schutz		12 V Batterie		Sicherheits- ventil
	Gurt- straffer		Gasdruck- dämpfer		Kraftstoff- tank		

Accent

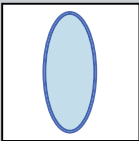
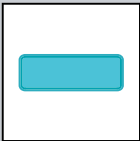

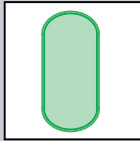
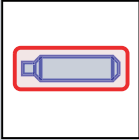
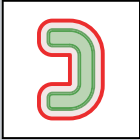
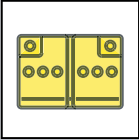
Legende

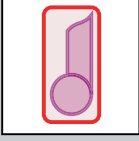
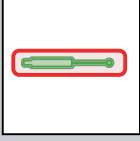
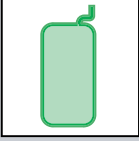
	Airbag		Karosserie- verstärkung		Steuergerät		Gastank
	Gas- generator		Überroll- schutz		12 V Batterie		Sicherheits- ventil
	Gurt- straffer		Gasdruck- dämpfer		Kraftstoff- tank		

Accent



Atos, 5-Türer

(Typ MX, MXL, MXI, 1998-2008)

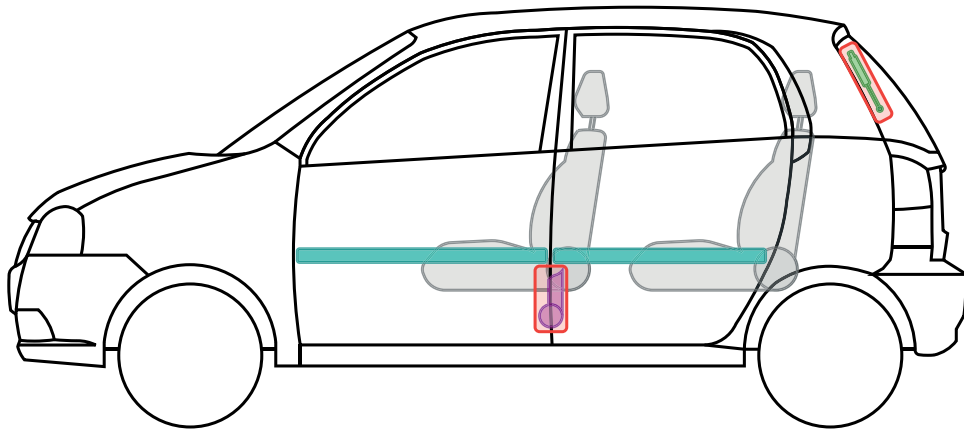
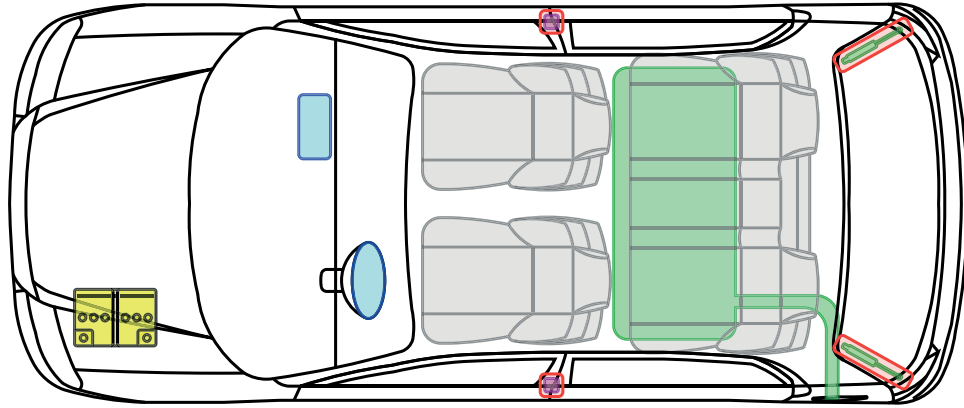



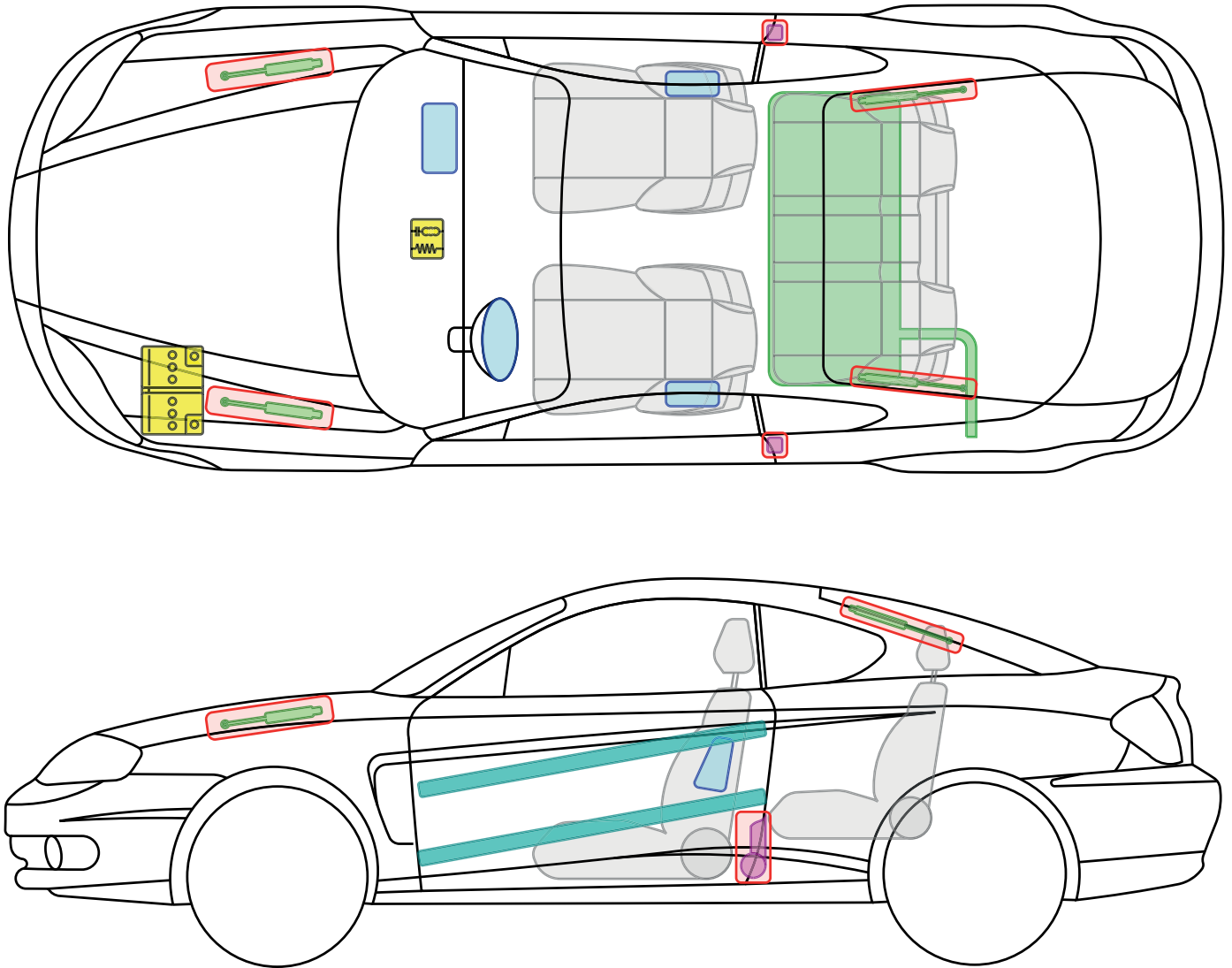

Legende

	Airbag		Karosserie- verstärkung		12 V Batterie		Gastank
	Gas- generator		Überroll- schutz		12 V Batterie		Sicherheits- ventil
	Gurt- straffer		Gasdruck- dämpfer		Kraftstoff- tank		

Atos

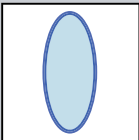
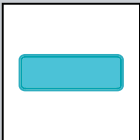

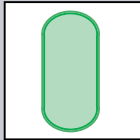
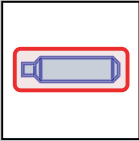
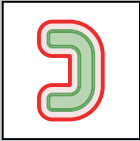
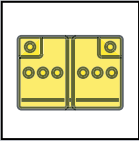

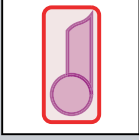
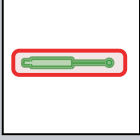
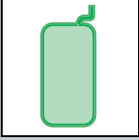
Legende

	Airbag		Karosserie- verstärkung		Steuergerät		Gastank
	Gas- generator		Überroll- schutz		12 V Batterie		Sicherheits- ventil
	Gurt- straffer		Gasdruck- dämpfer		Kraftstoff- tank		

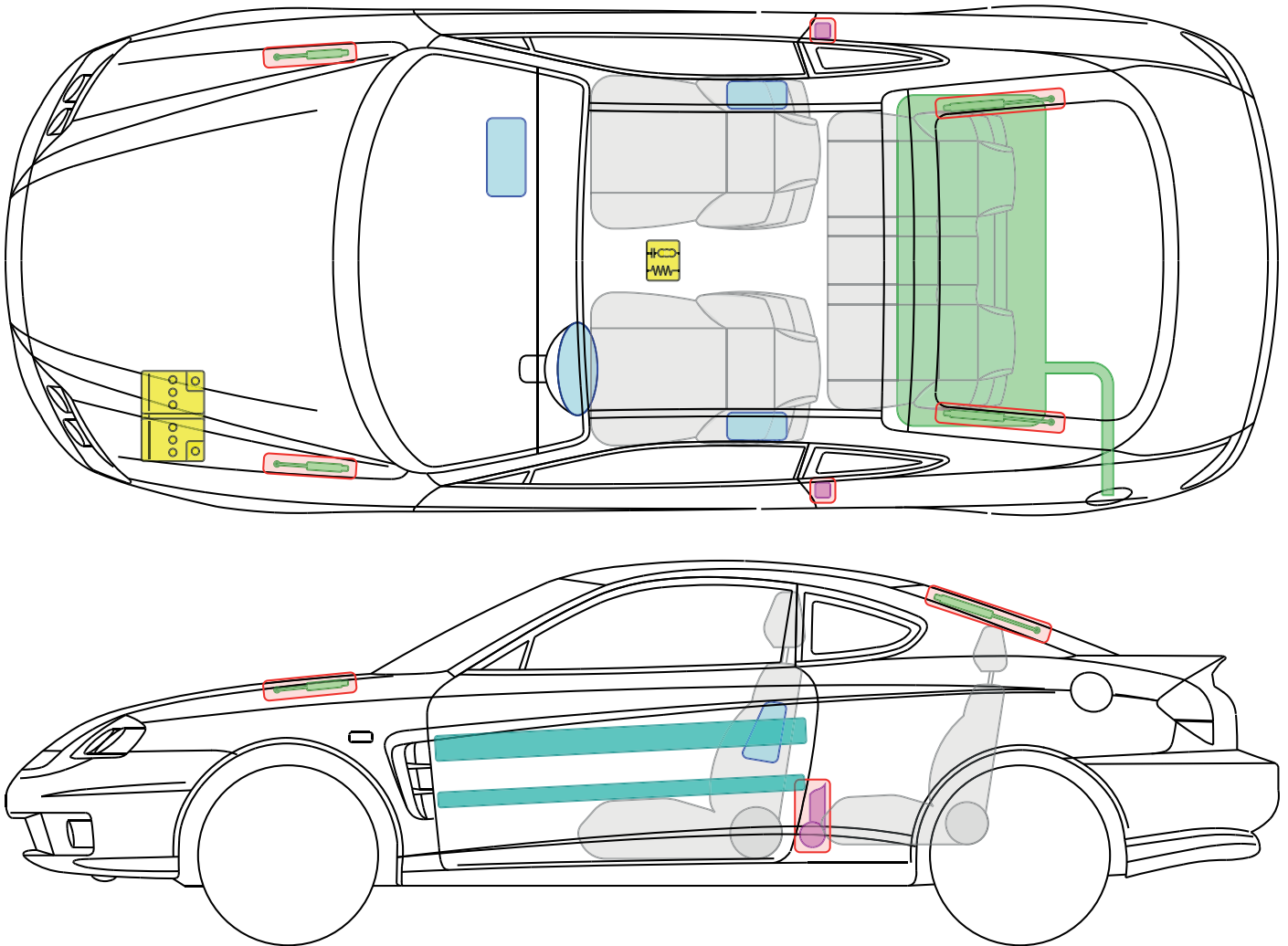
Coupe



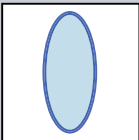
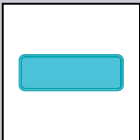

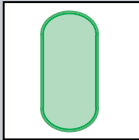
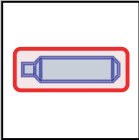
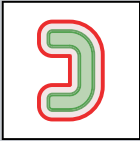
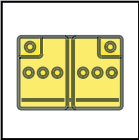
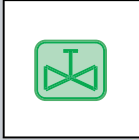
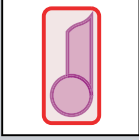
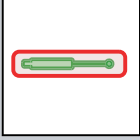
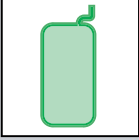

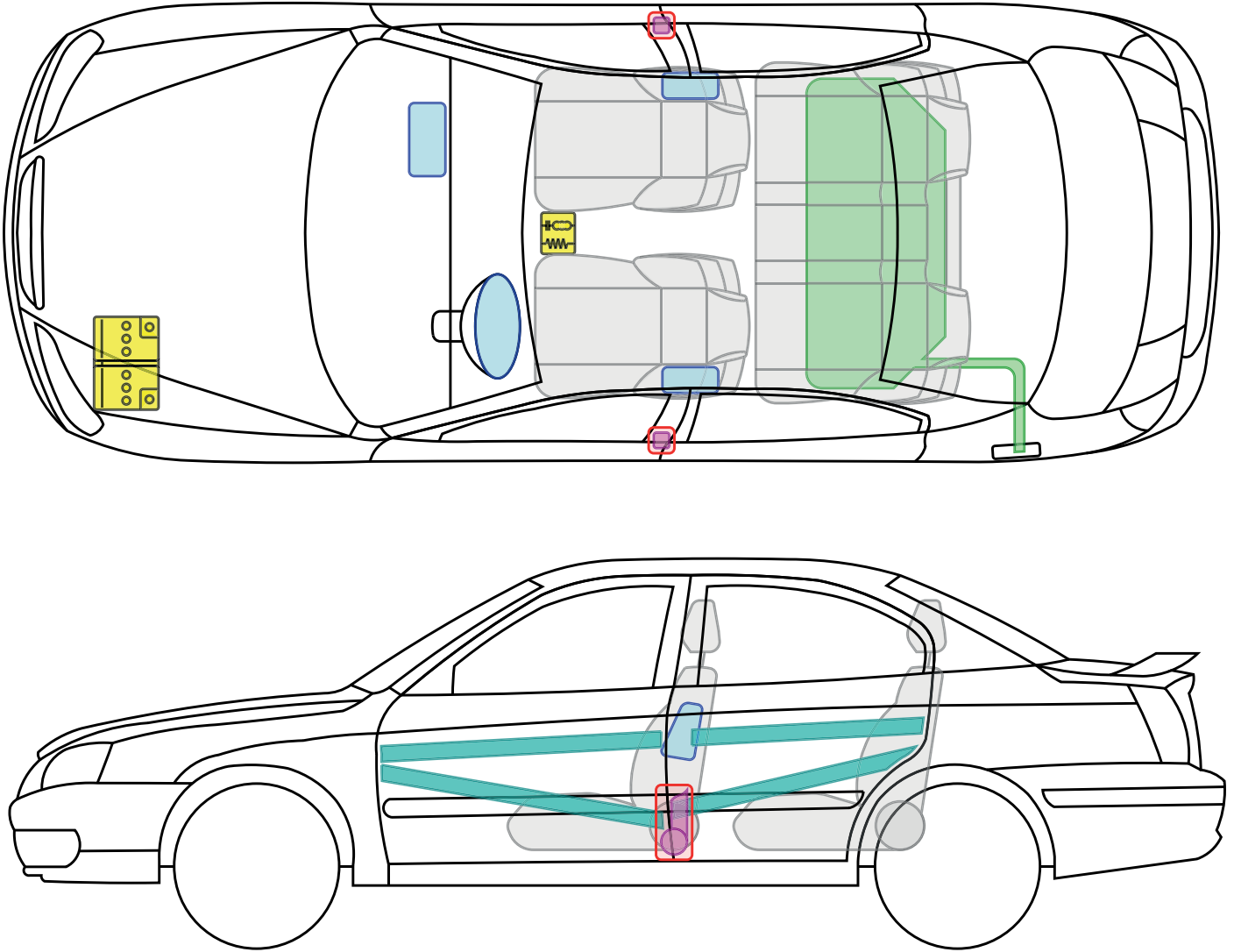

Legende

	Airbag		Karosserie- verstärkung		Steuergerät		Gastank
	Gas- generator		Überroll- schutz		12 V Batterie		Sicherheits- ventil
	Gurt- straffer		Gasdruck- dämpfer		Kraftstoff- tank		

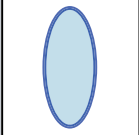
Coupe

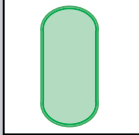
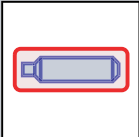
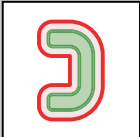
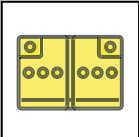

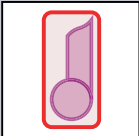
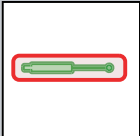

Legende

	Airbag		Karosserie- verstärkung		Steuergerät		Gastank
	Gas- generator		Überschallschutz		12 V Batterie		Sicherheits- ventil
	Gurt- straffer		Gasdruck- dämpfer		Kraftstoff- tank		

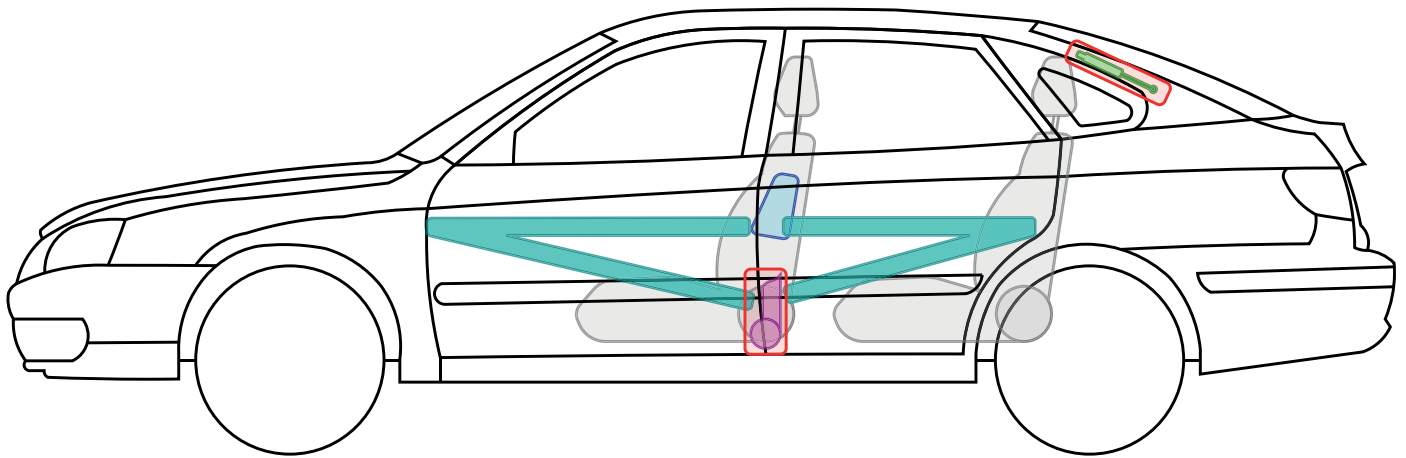
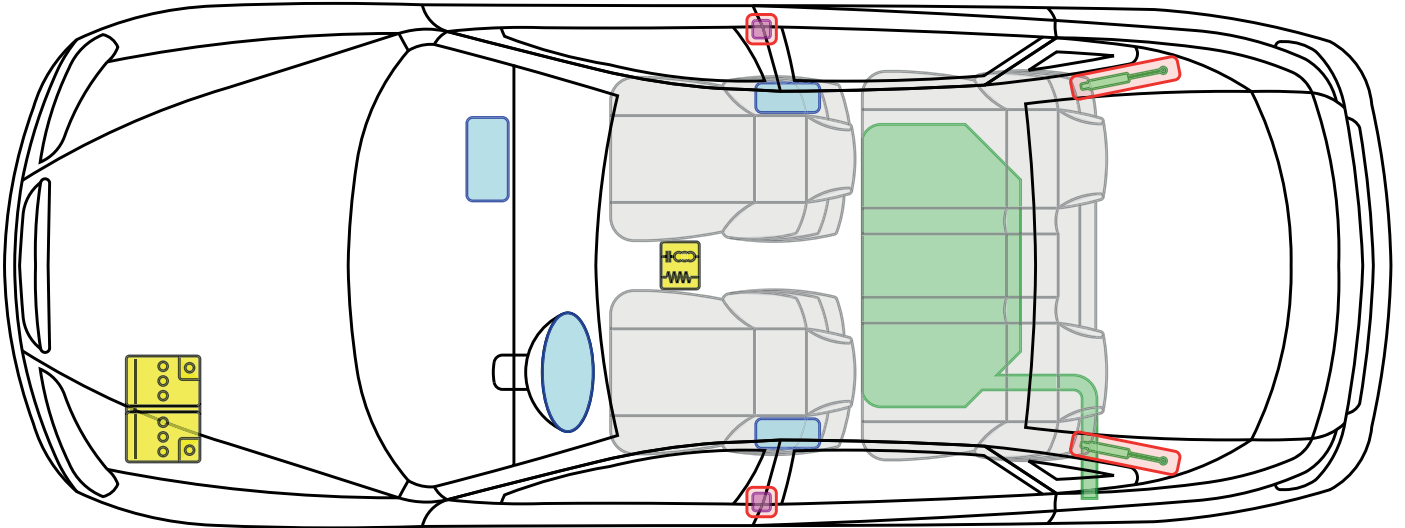
Elantra



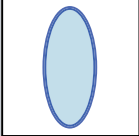
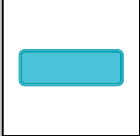
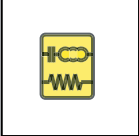
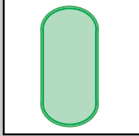
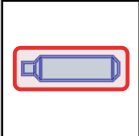
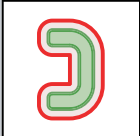
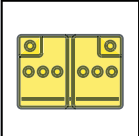
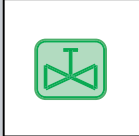
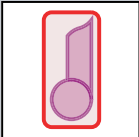
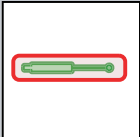



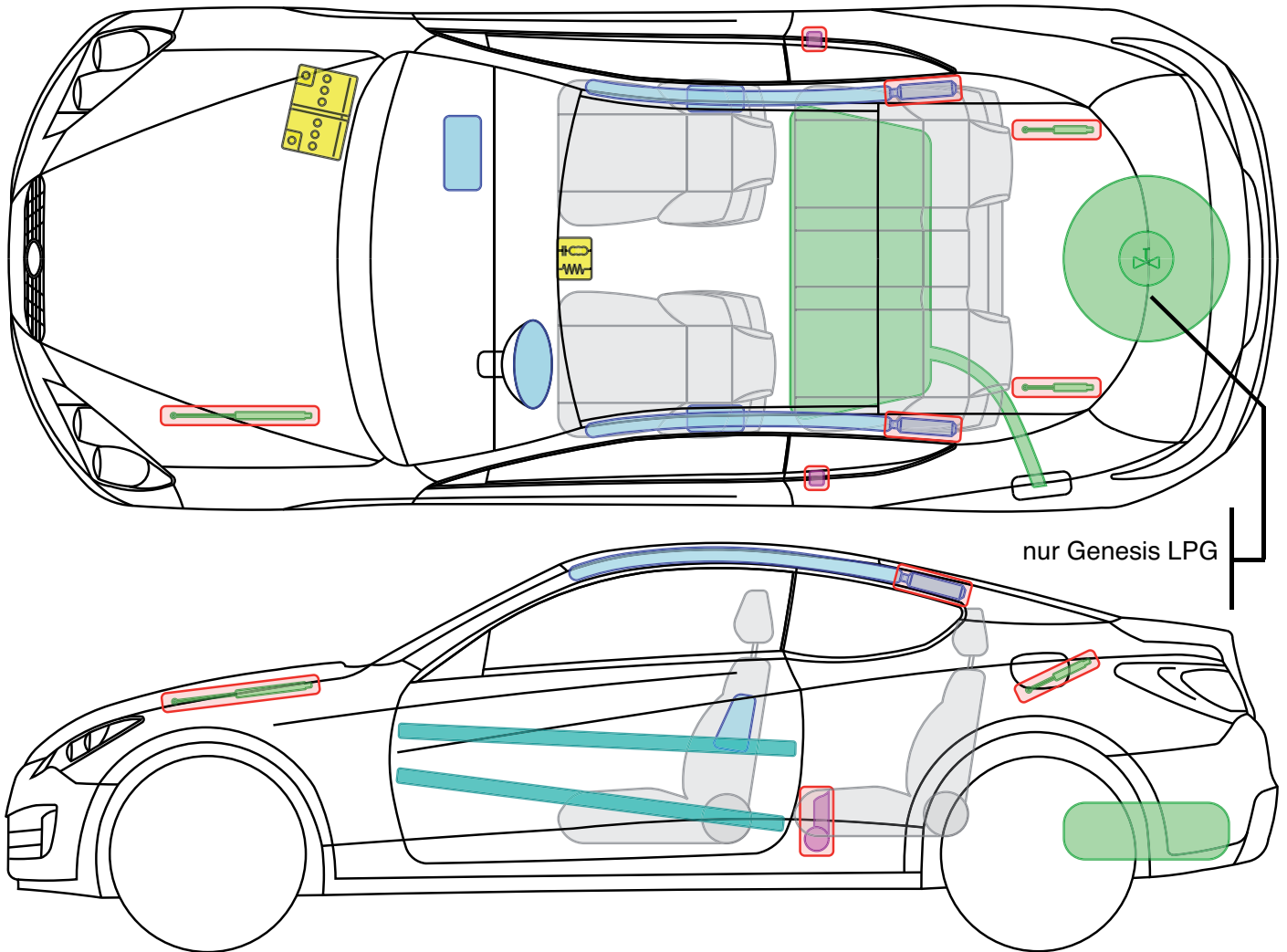

Legende

	Airbag		Karosserie- verstärkung		Steuergerät		Gastank
	Gas- generator		Überroll- schutz		12 V Batterie		Sicherheits- ventil
	Gurt- straffer		Gasdruck- dämpfer		Kraftstoff- tank		

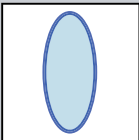
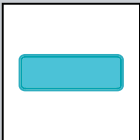
Elantra

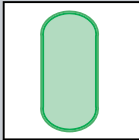
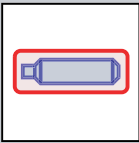
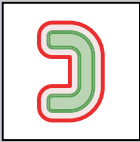
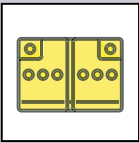

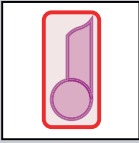
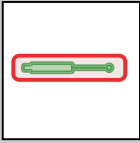



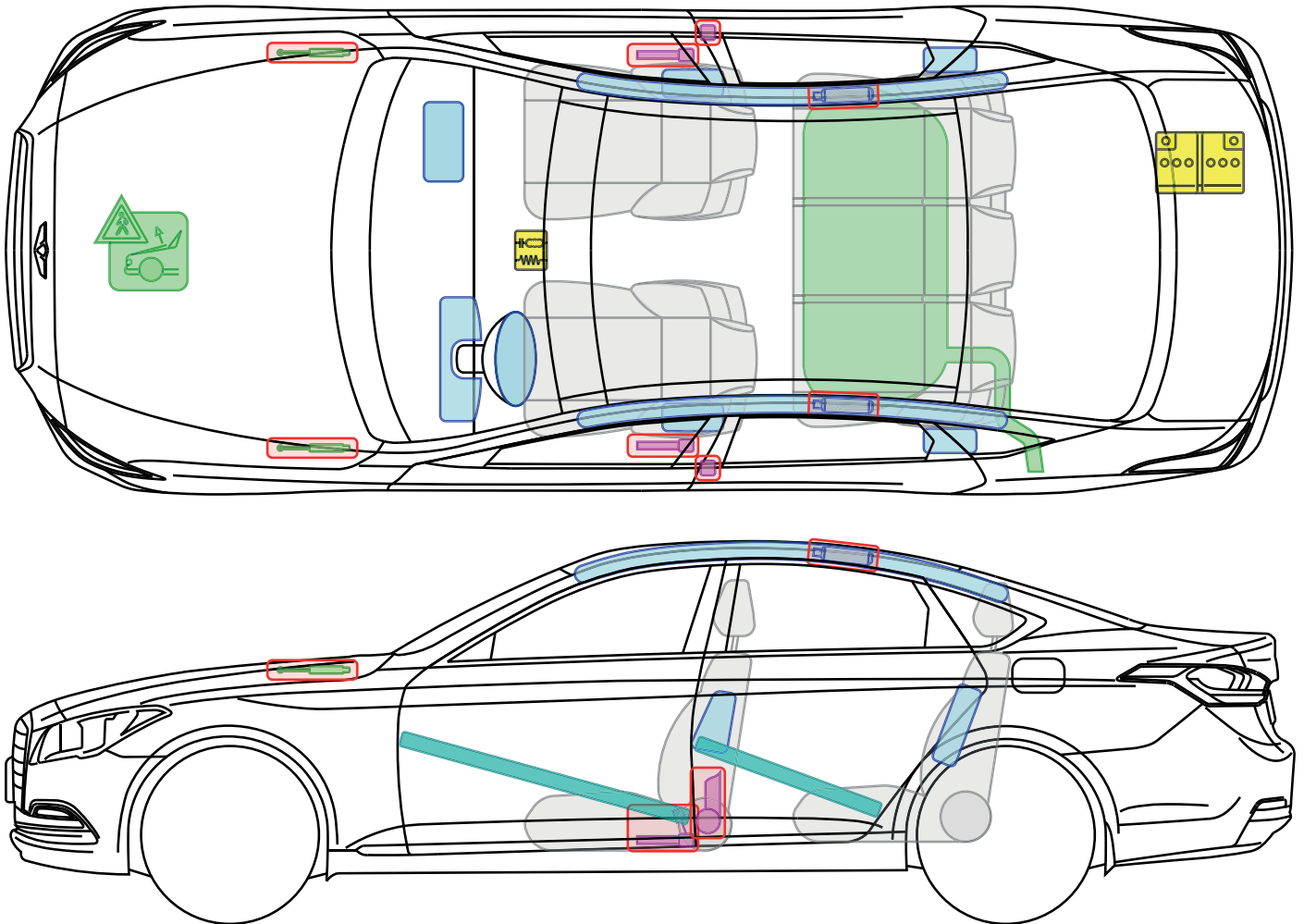

Legende

	Airbag		Karosserie- verstärkung		Steuergerät		Gastank
	Gas- generator		Überroll- schutz		12 V Batterie		Sicherheits- ventil
	Gurt- straffer		Gasdruck- dämpfer		Kraftstoff- tank		

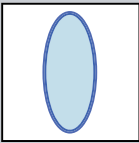
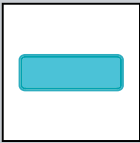
Genesis Coupe

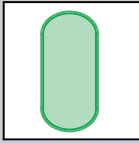
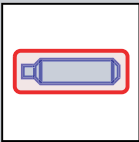
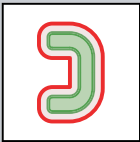
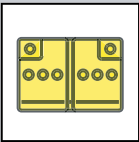

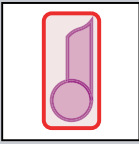
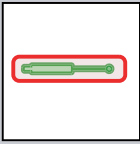

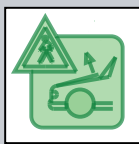

Legende

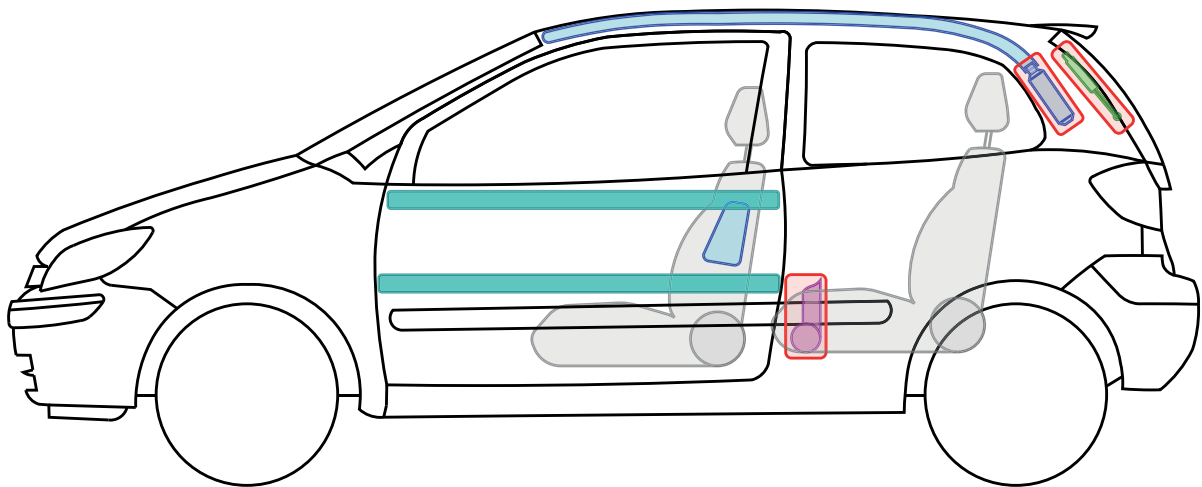
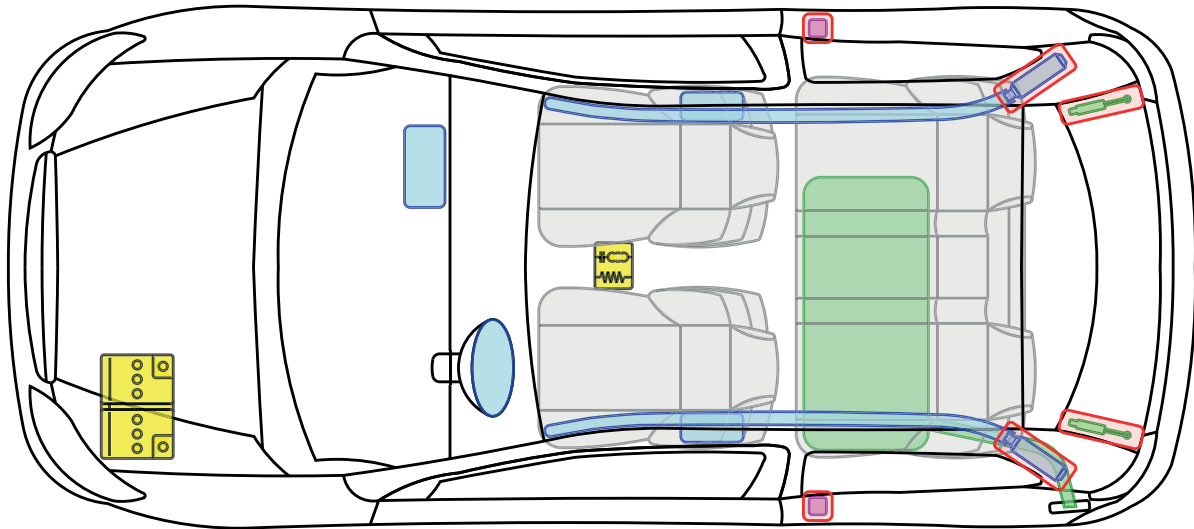
	Airbag		Karosserie- verstärkung		Steuergerät		Gastank
	Gas- generator		Überroll- schutz		12 V Batterie		Sicherheits- ventil
	Gurt- straffer		Gasdruck- dämpfer		Kraftstoff- tank		Fußgänger- schutzsystem

Genesis

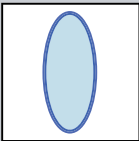
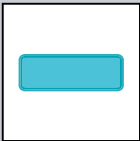

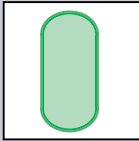
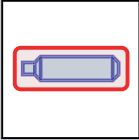
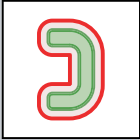
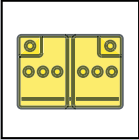

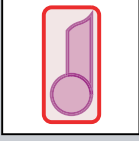
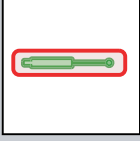
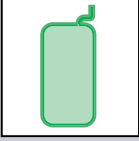

Legende

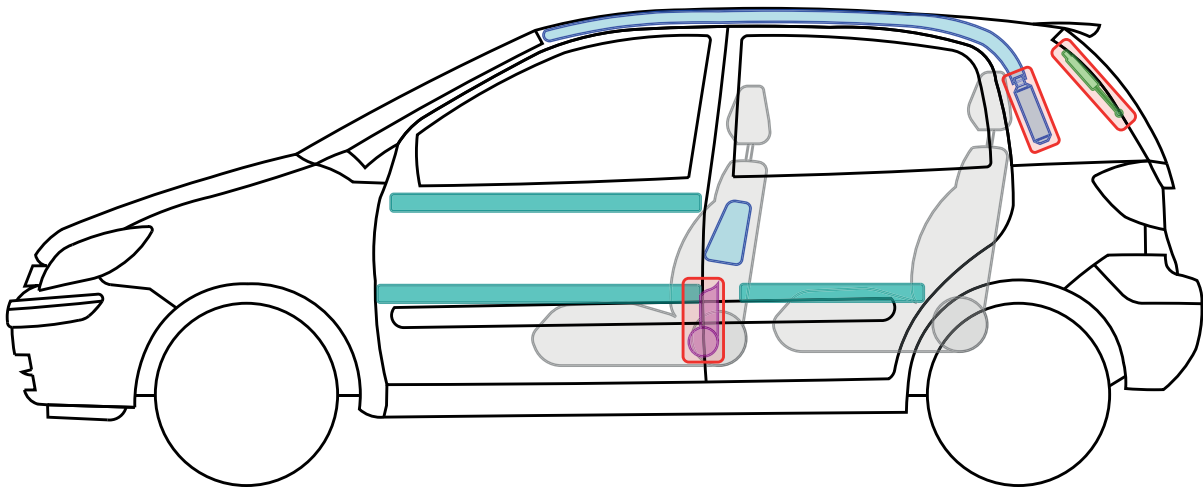
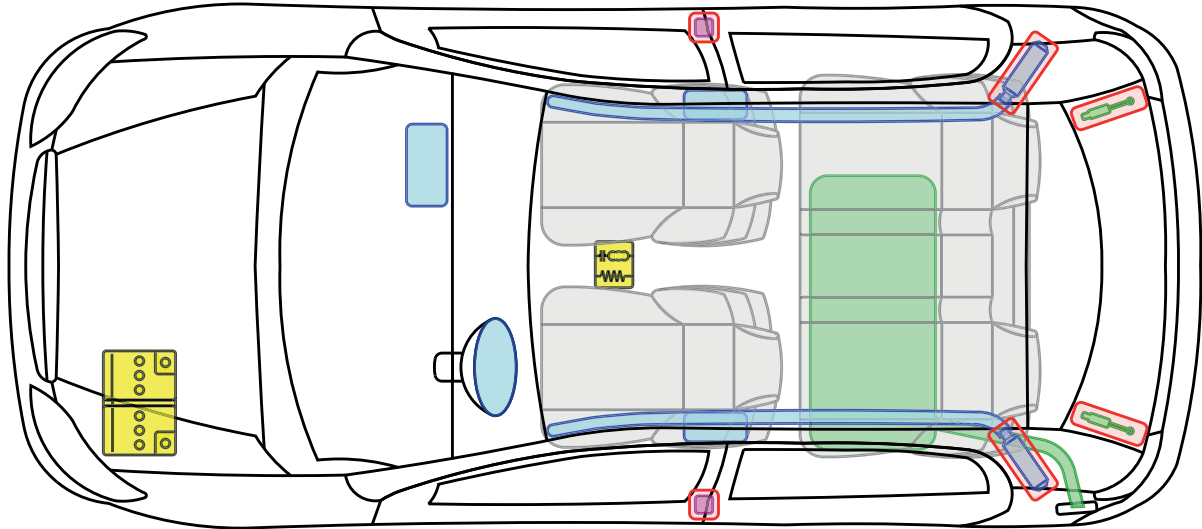
	Airbag		Karosserie- verstärkung		Steuergerät		Gastank
	Gas- generator		Überroll- schutz		12 V Batterie		Sicherheits- ventil
	Gurt- straffer		Gasdruck- dämpfer		Kraftstoff- tank		

Getz

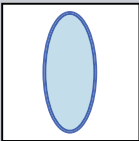
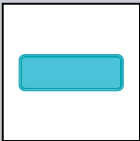

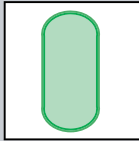
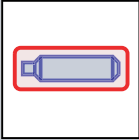
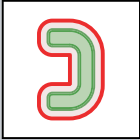
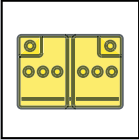
Legende

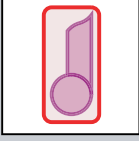
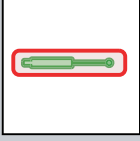
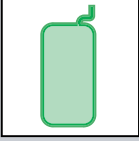

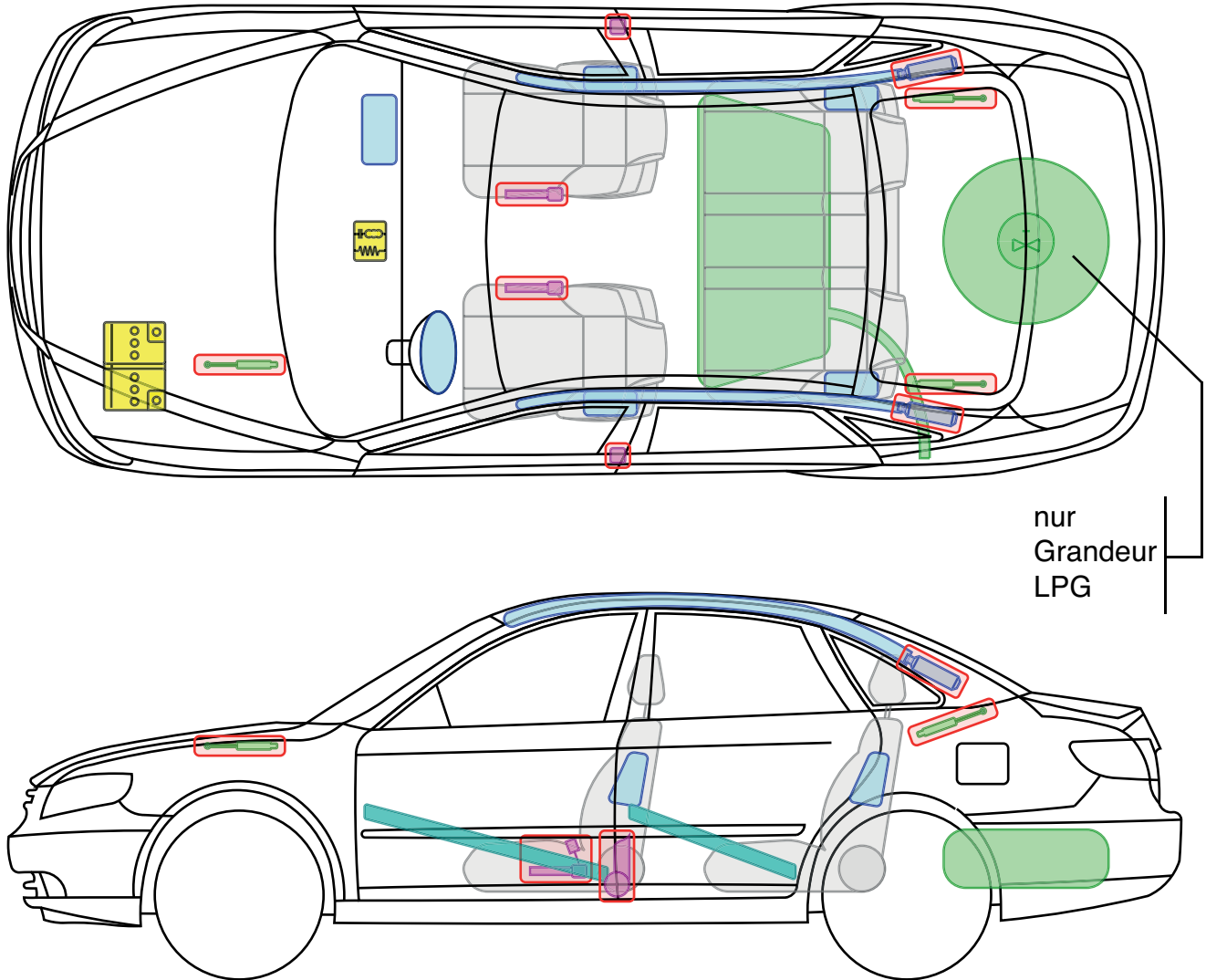

	Airbag		Karosserie- verstärkung		Steuergerät		Gastank
	Gas- generator		Überroll- schutz		12 V Batterie		Sicherheits- ventil
	Gurt- straffer		Gasdruck- dämpfer		Kraftstoff- tank		

Getz

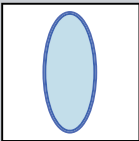
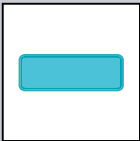

nur
Grandeur
LPG

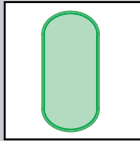
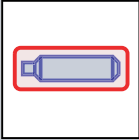
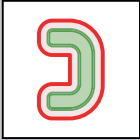
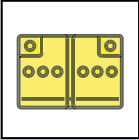

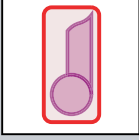
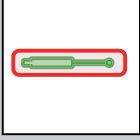
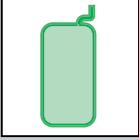

Legende

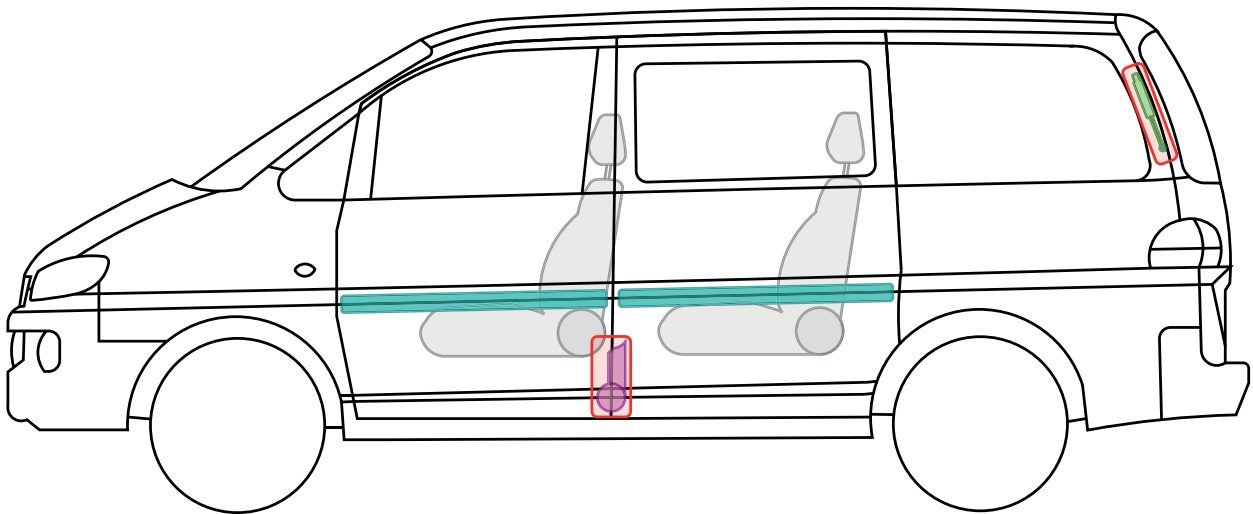
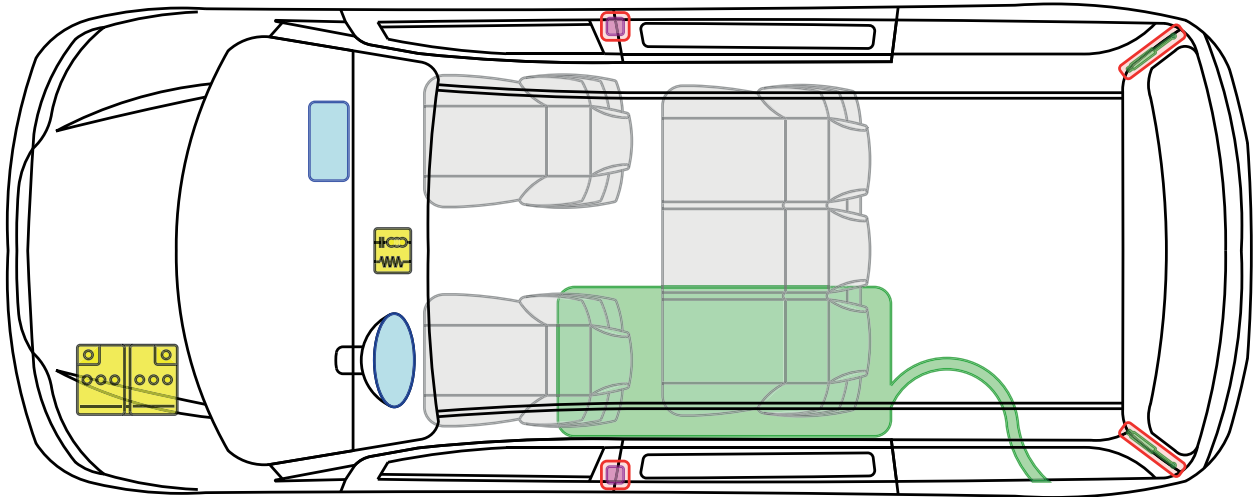
	Airbag		Karosserie- verstärkung		Steuergerät		Gastank
	Gas- generator		Überroll- schutz		12 V Batterie		Sicherheits- ventil
	Gurt- straffer		Gasdruck- dämpfer		Kraftstoff- tank		

Grandeur

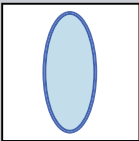
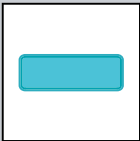

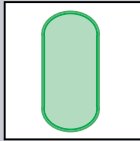
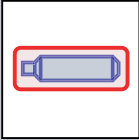
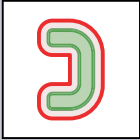
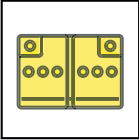

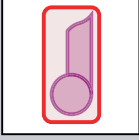
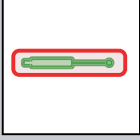
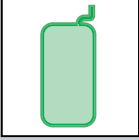

Legende

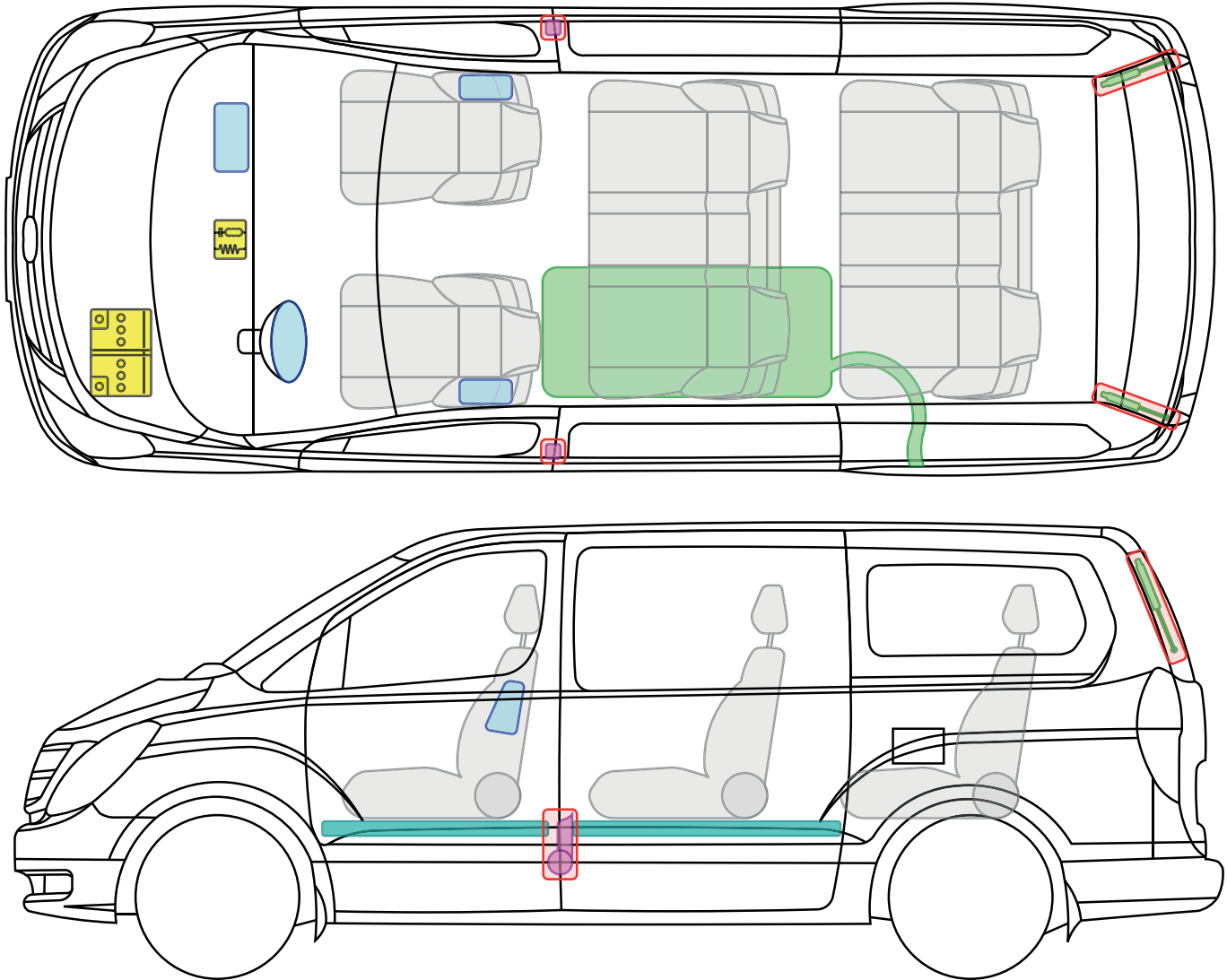
	Airbag		Karosserie- verstärkung		Steuergerät		Gastank
	Gas- generator		Überroll- schutz		12 V Batterie		Sicherheits- ventil
	Gurt- straffer		Gasdruck- dämpfer		Kraftstoff- tank		

H-1

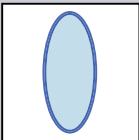
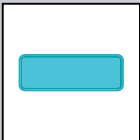

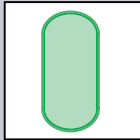
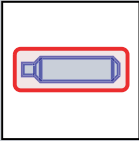
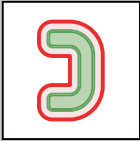
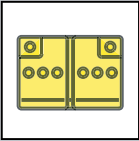

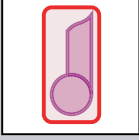
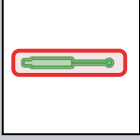
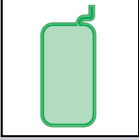

Legende

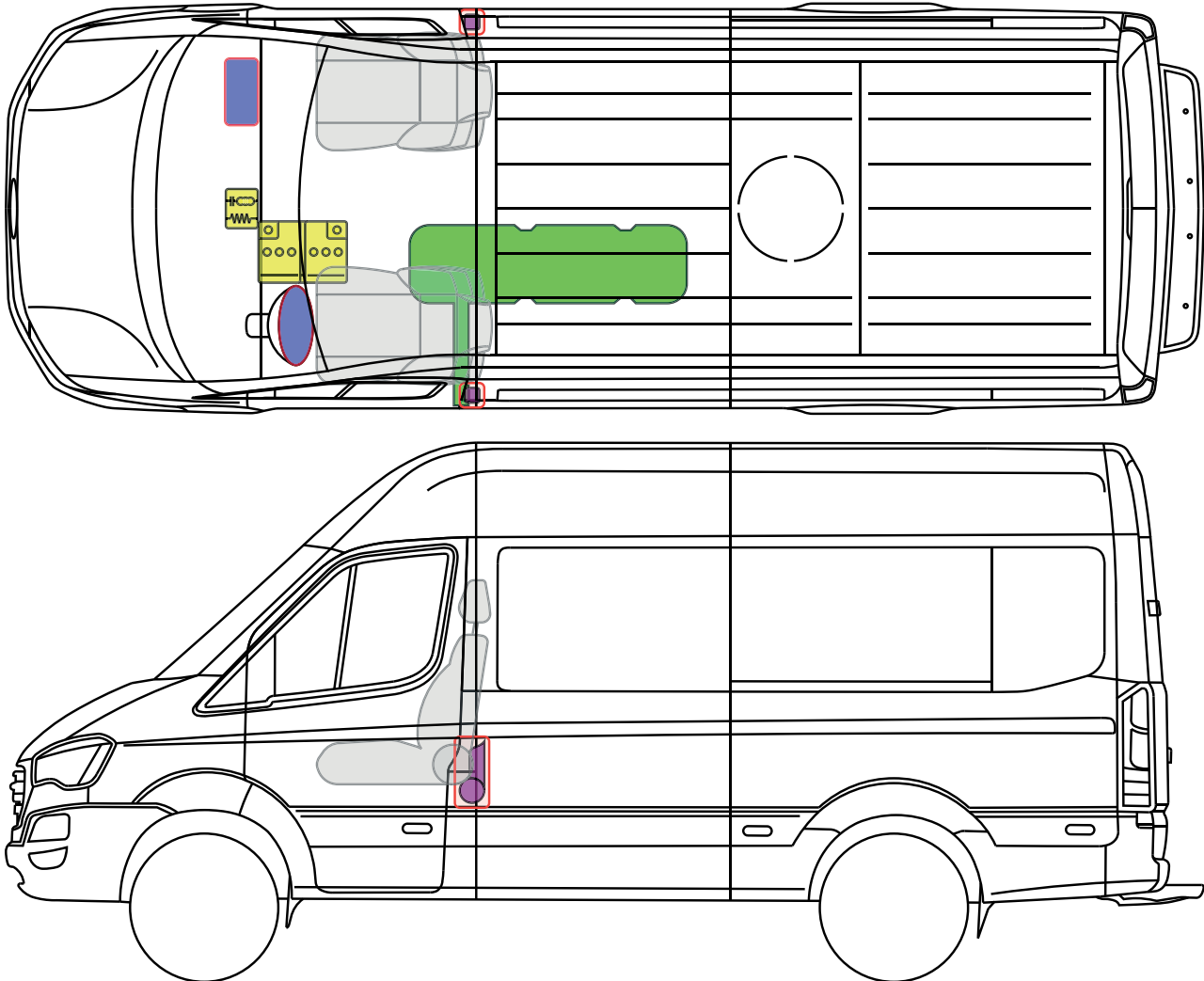
	Airbag		Karosserie- verstärkung		Steuergerät		Gastank
	Gas- generator		Überroll- schutz		12 V Batterie		Sicherheits- ventil
	Gurt- straffer		Gasdruck- dämpfer		Kraftstoff- tank		

H-1

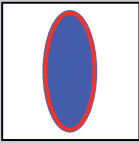
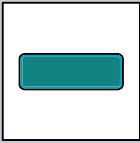
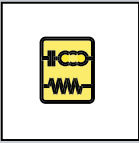
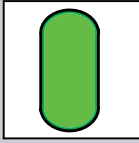
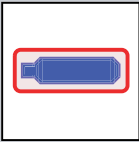

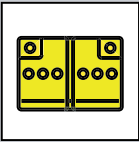
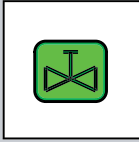
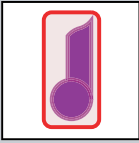
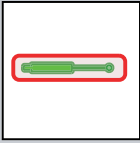

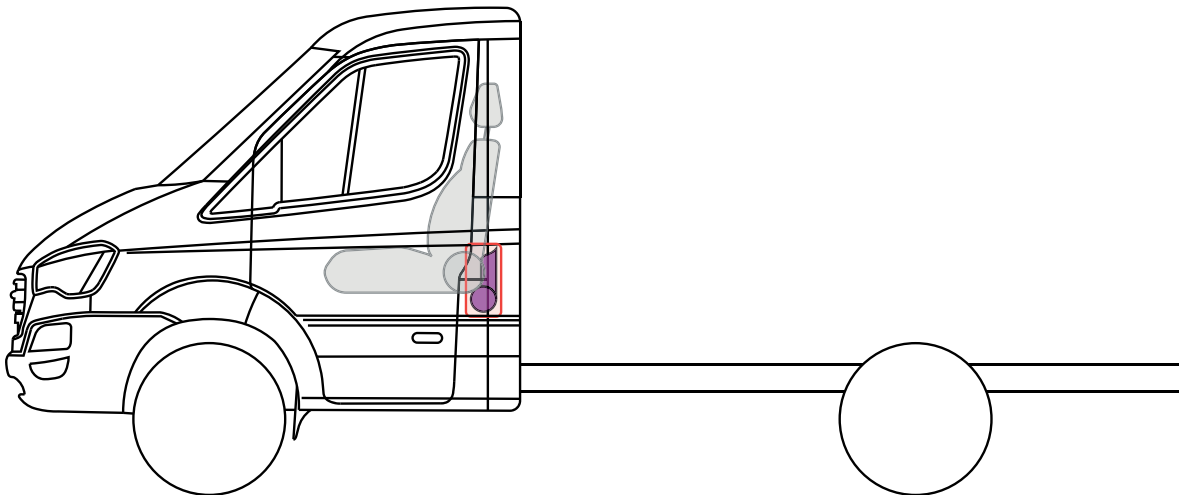
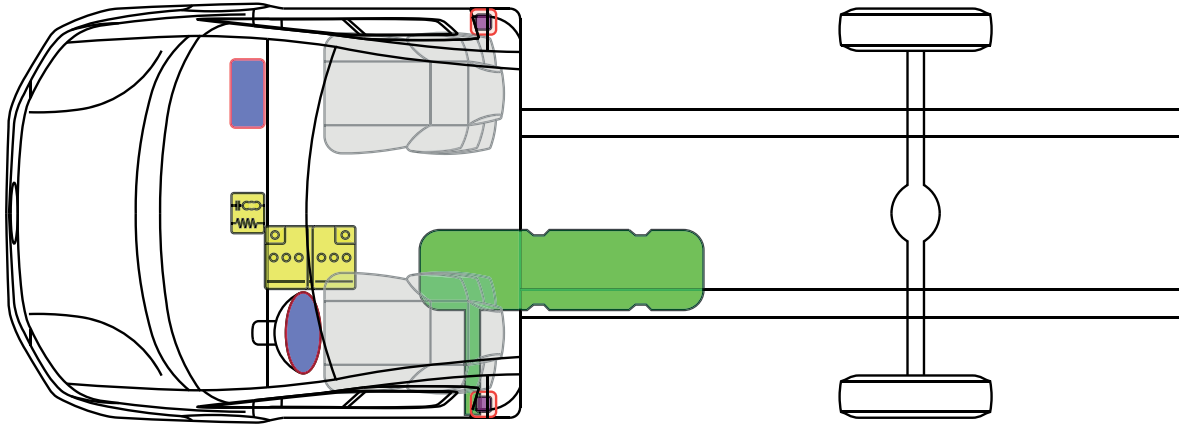

Legende

	Airbag		Karosserie- verstärkung		Steuergerät		Gastank
	Gas- generator		Überroll- schutz		12 V Batterie		Sicherheits- ventil
	Gurt- straffer		Gasdruck- dämpfer		Kraftstoff- tank		

H-350

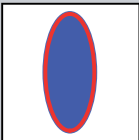
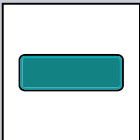
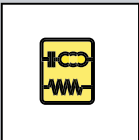
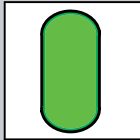
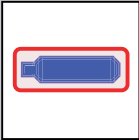

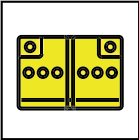
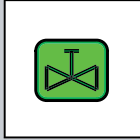
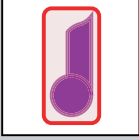
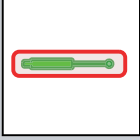
Legende

	Airbag		Karosserie- verstärkung		Steuergerät		Gastank
	Gas- generator		Überroll- schutz		12 V Batterie		Sicherheits- ventil
	Gurt- straffer		Gasdruck- dämpfer		Kraftstoff- tank		

H-350



H-350, Bus

(Typ EU, ab 2016)

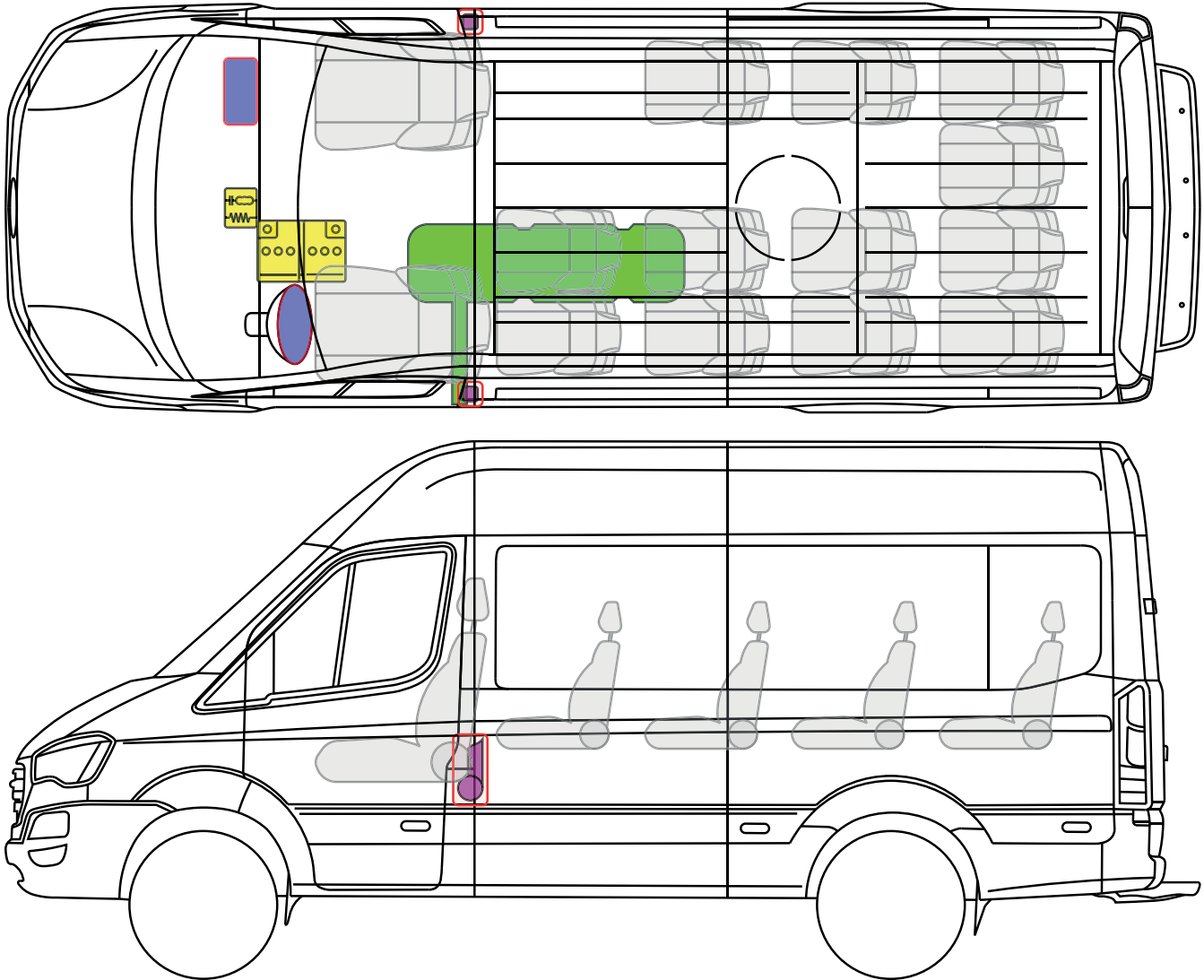



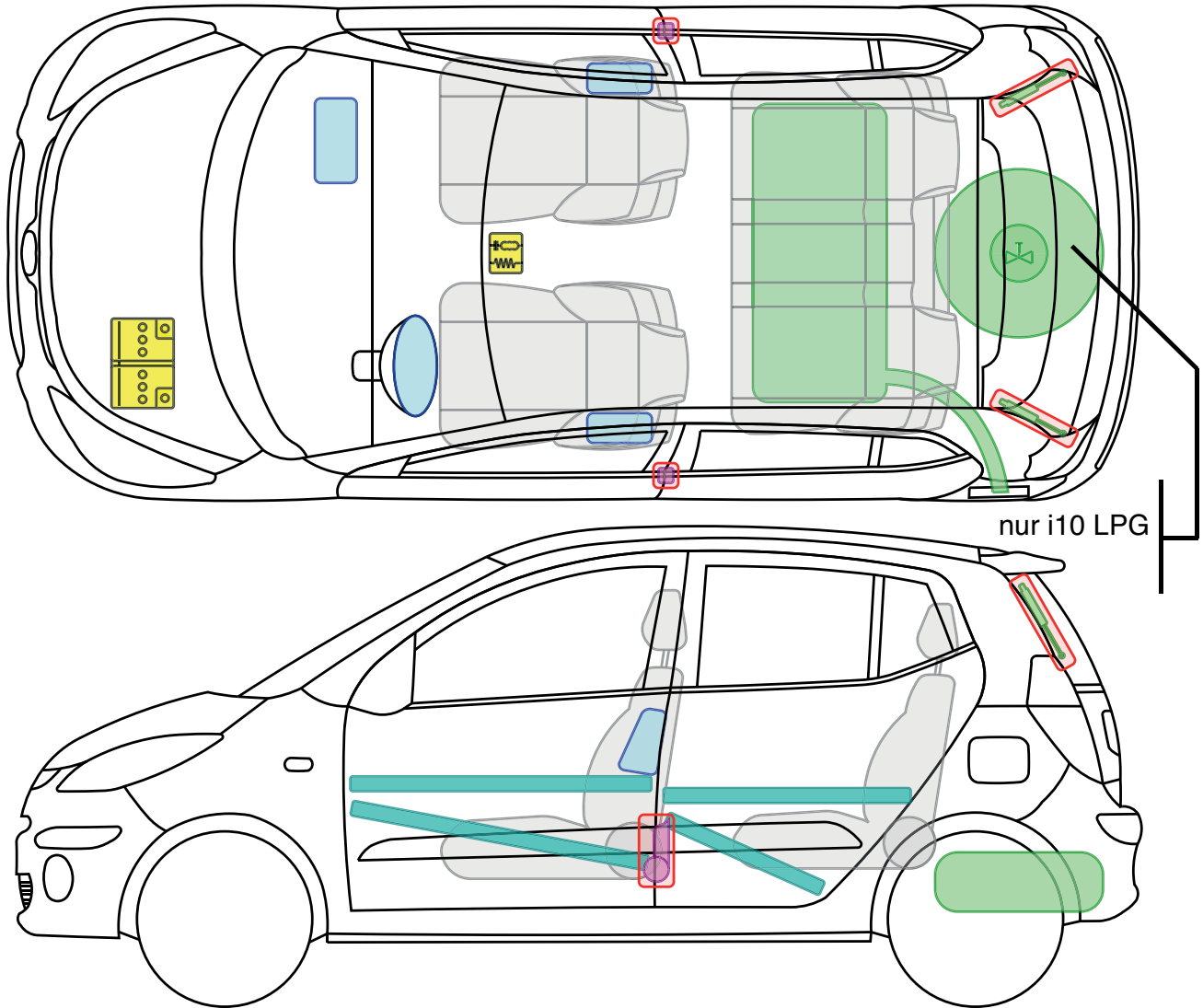

Legende

	Airbag		Karosserie- verstärkung		Steuergerät		Gastank
	Gas- generator		Überroll- schutz		12 V Batterie		Sicherheits- ventil
	Gurt- straffer		Gasdruck- dämpfer		Kraftstoff- tank		

H-350

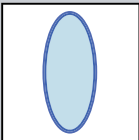
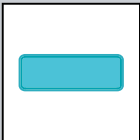

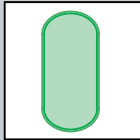
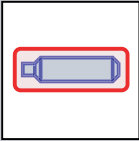
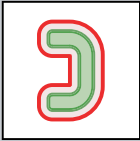
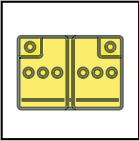

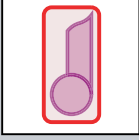
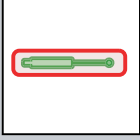
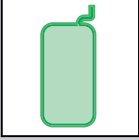

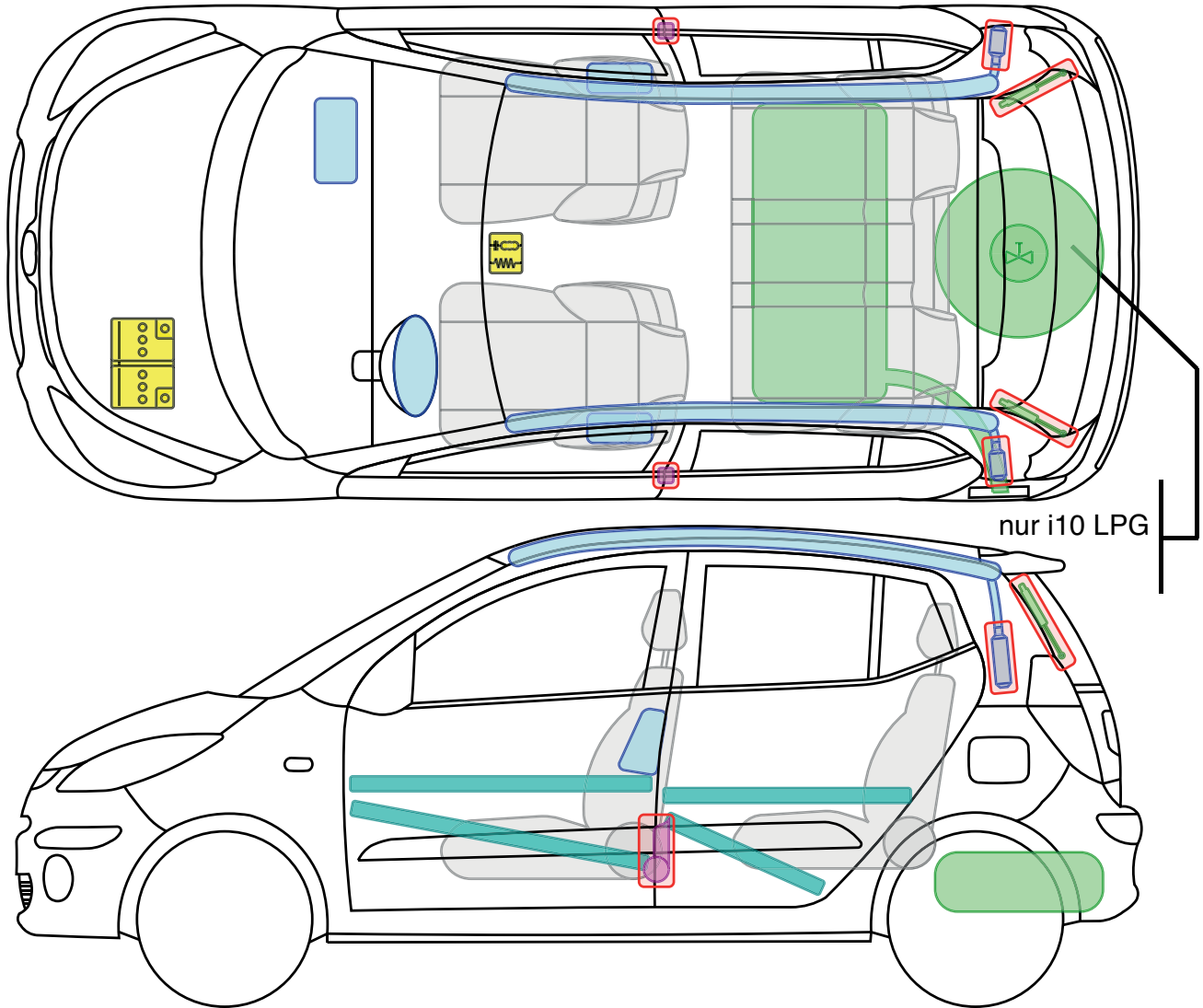

Legende

	Airbag		Karosserie- verstärkung		Steuergerät		Gastank
	Gas- generator		Überroll- schutz		12 V Batterie		Sicherheits- ventil
	Gurt- straffer		Gasdruck- dämpfer		Kraftstoff- tank		

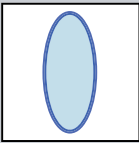
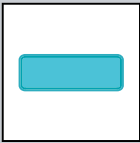
i10

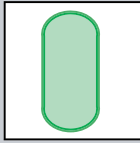
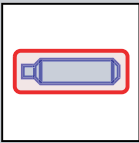
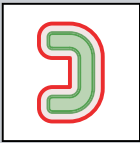
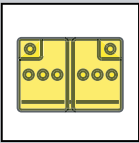

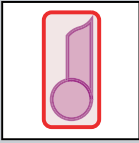
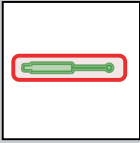

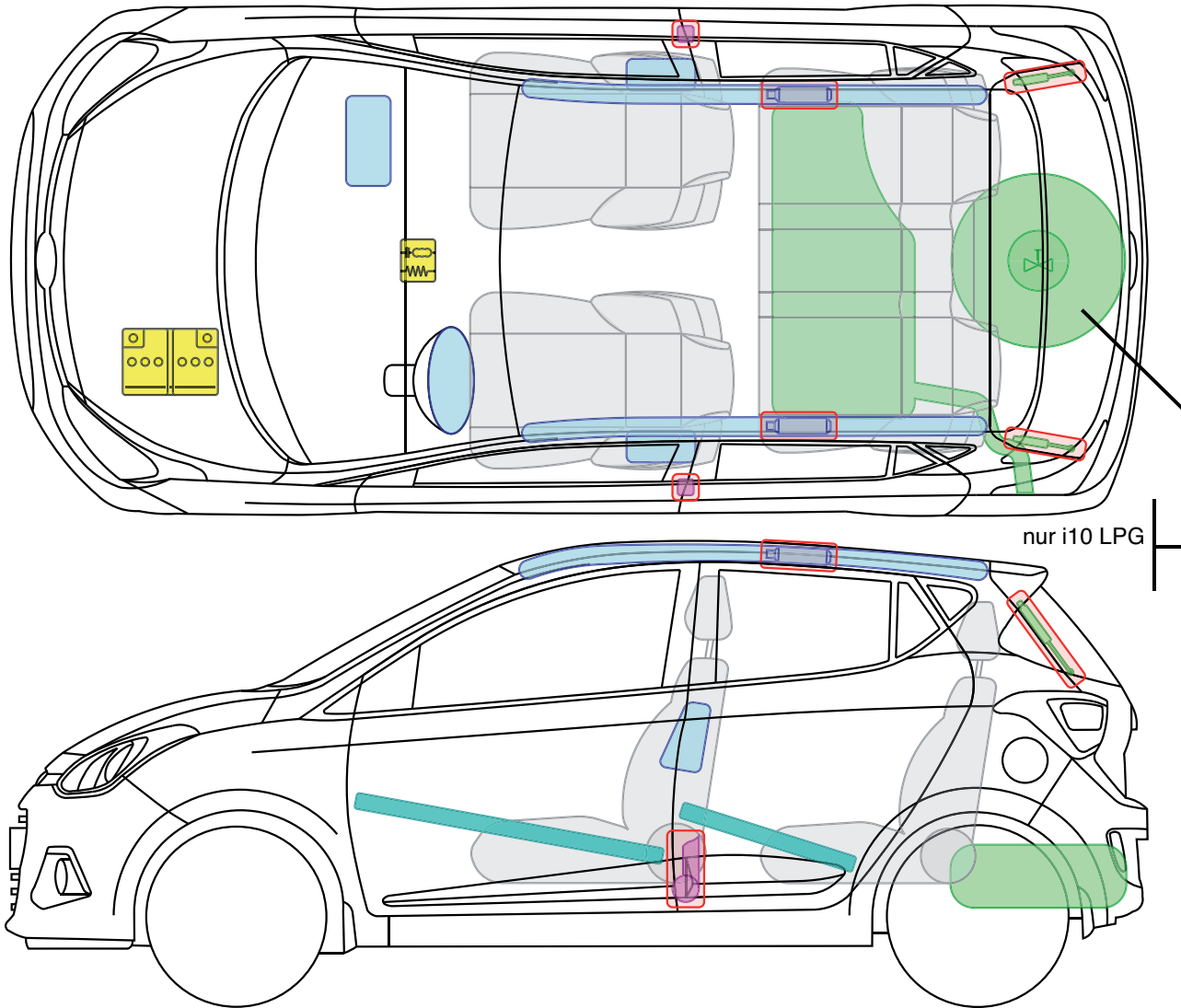

Legende

	Airbag		Karosserie- verstärkung		Steuergerät		Gastank
	Gas- generator		Überroll- schutz		12 V Batterie		Sicherheits- ventil
	Gurt- straffer		Gasdruck- dämpfer		Kraftstoff- tank		

i10

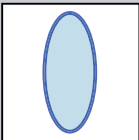
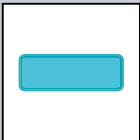

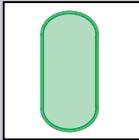
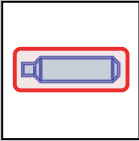
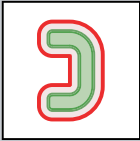
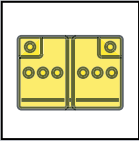

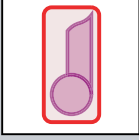
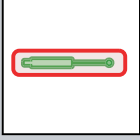
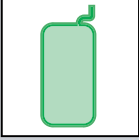

Legende

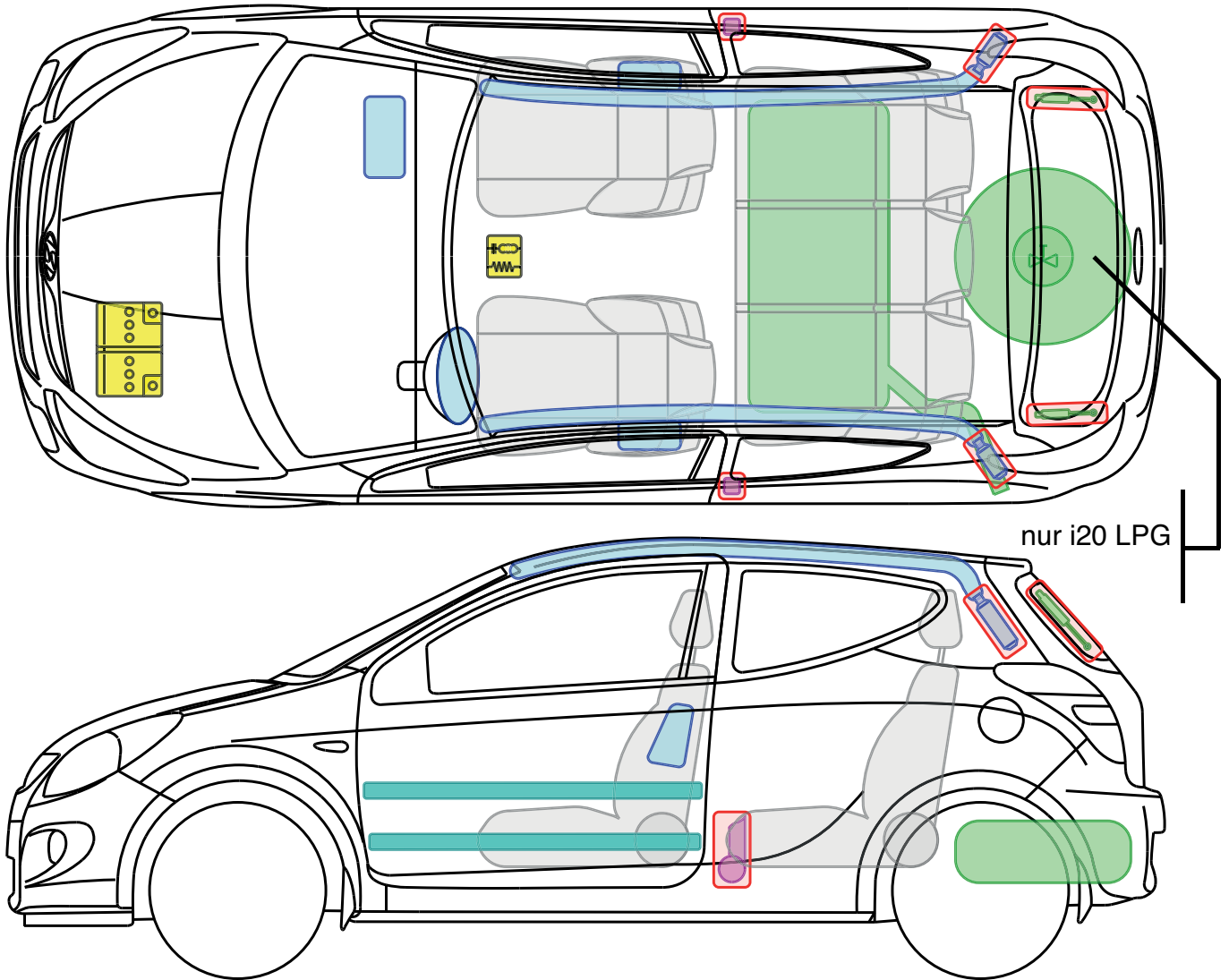
	Airbag		Karosserie- verstärkung		Steuergerät		Gastank
	Gas- generator		Überroll- schutz		12 V Batterie		Sicherheits- ventil
	Gurt- straffer		Gasdruck- dämpfer		Kraftstoff- tank		

i10

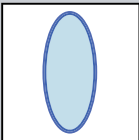
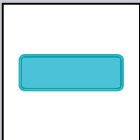

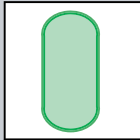
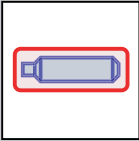
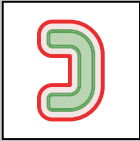
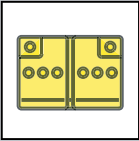

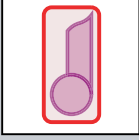
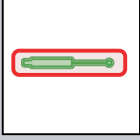
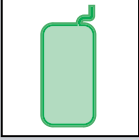

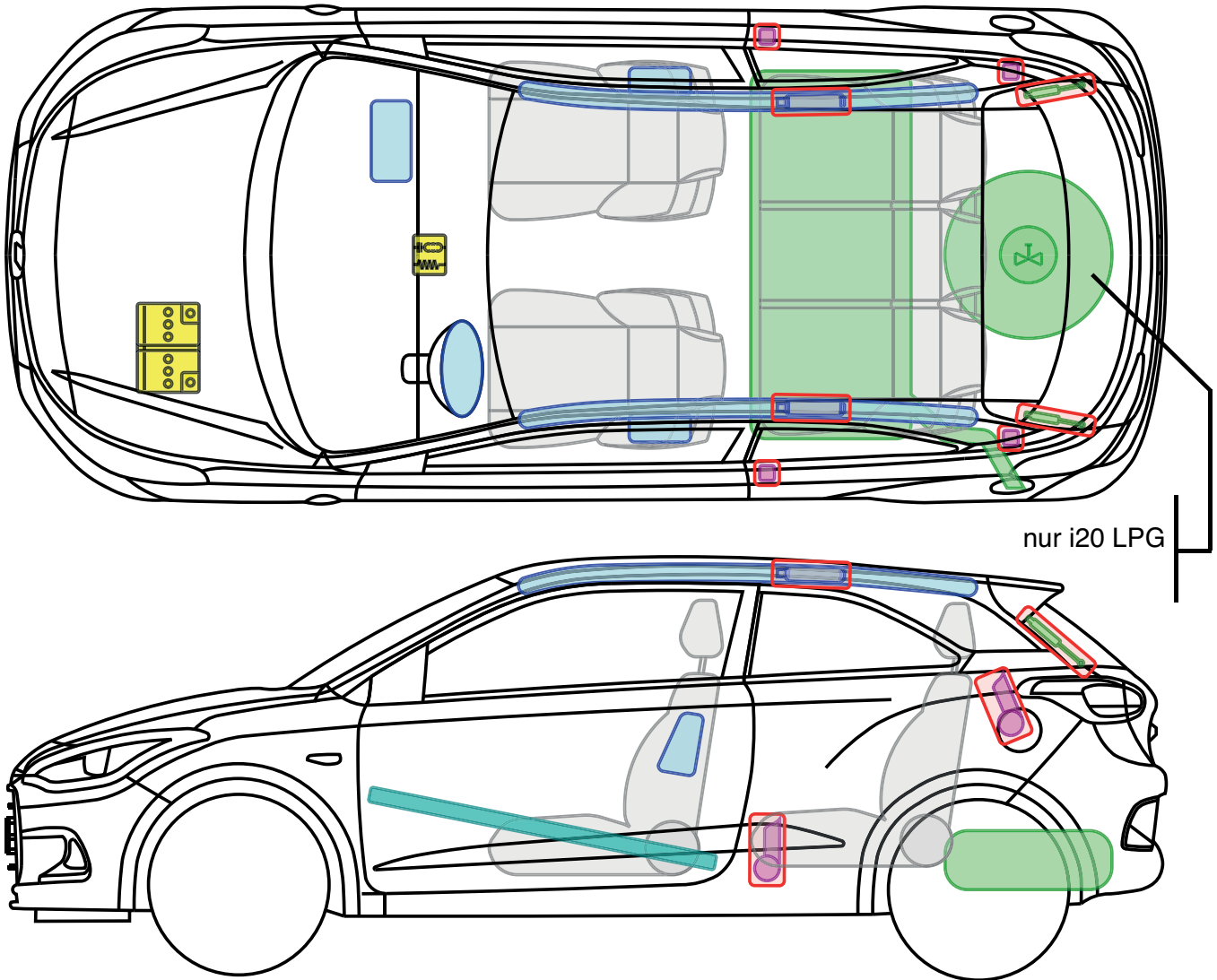

Legende

	Airbag		Karosserie- verstärkung		Steuergerät		Gastank
	Gas- generator		Überroll- schutz		12 V Batterie		Sicherheits- ventil
	Gurt- straffer		Gasdruck- dämpfer		Kraftstoff- tank		

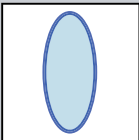
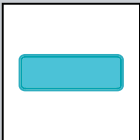
i20

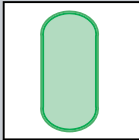
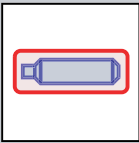
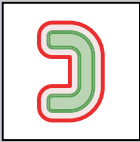
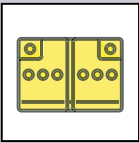

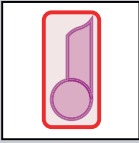
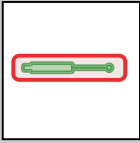



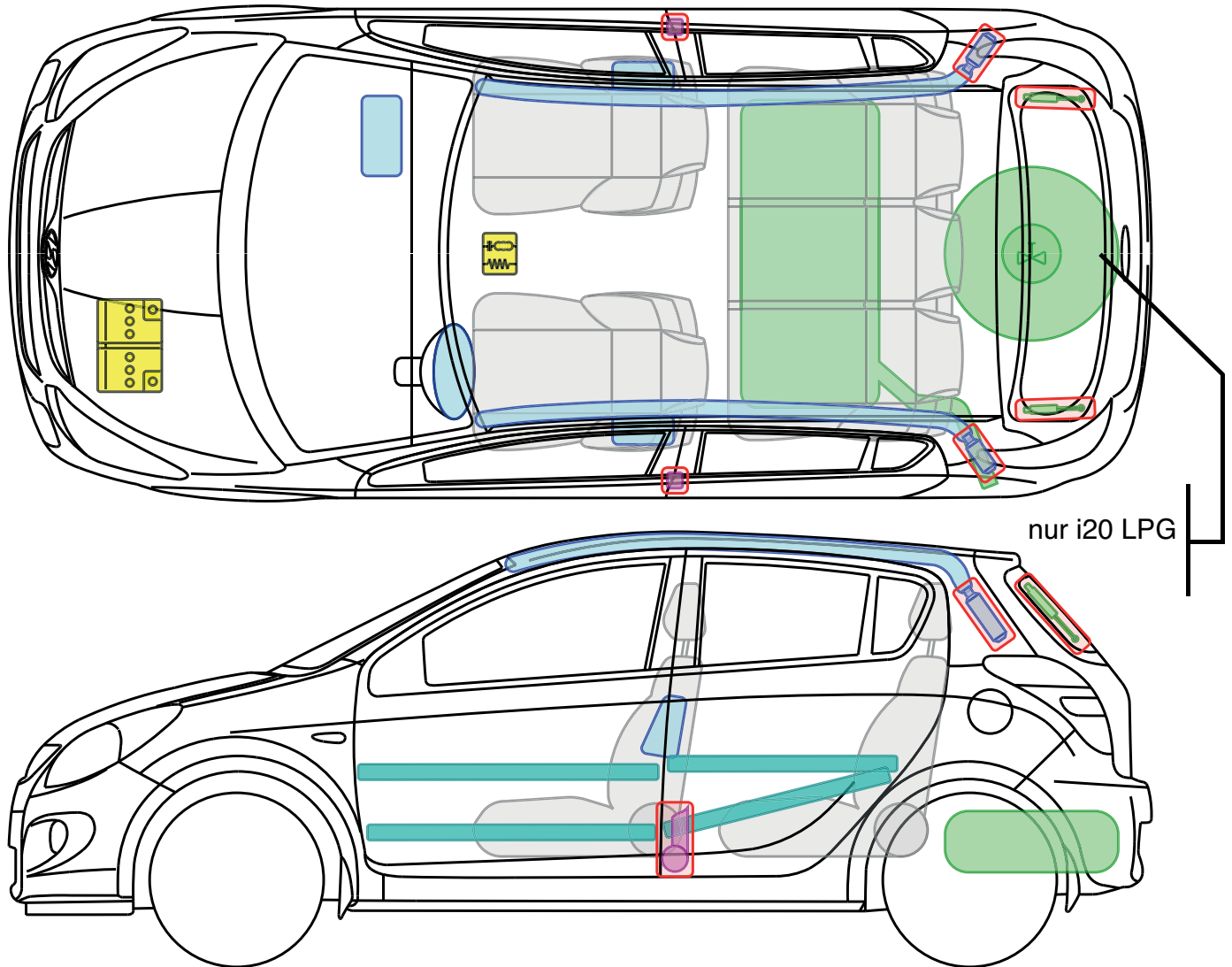

Legende

	Airbag		Karosserie- verstärkung		Steuergerät		Gastank
	Gas- generator		Überroll- schutz		12 V Batterie		Sicherheits- ventil
	Gurt- straffer		Gasdruck- dämpfer		Kraftstoff- tank		

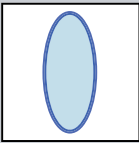
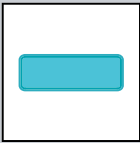
i20 Coupe

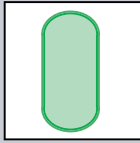
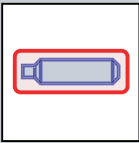
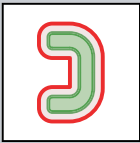
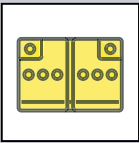

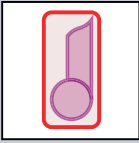
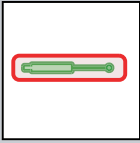

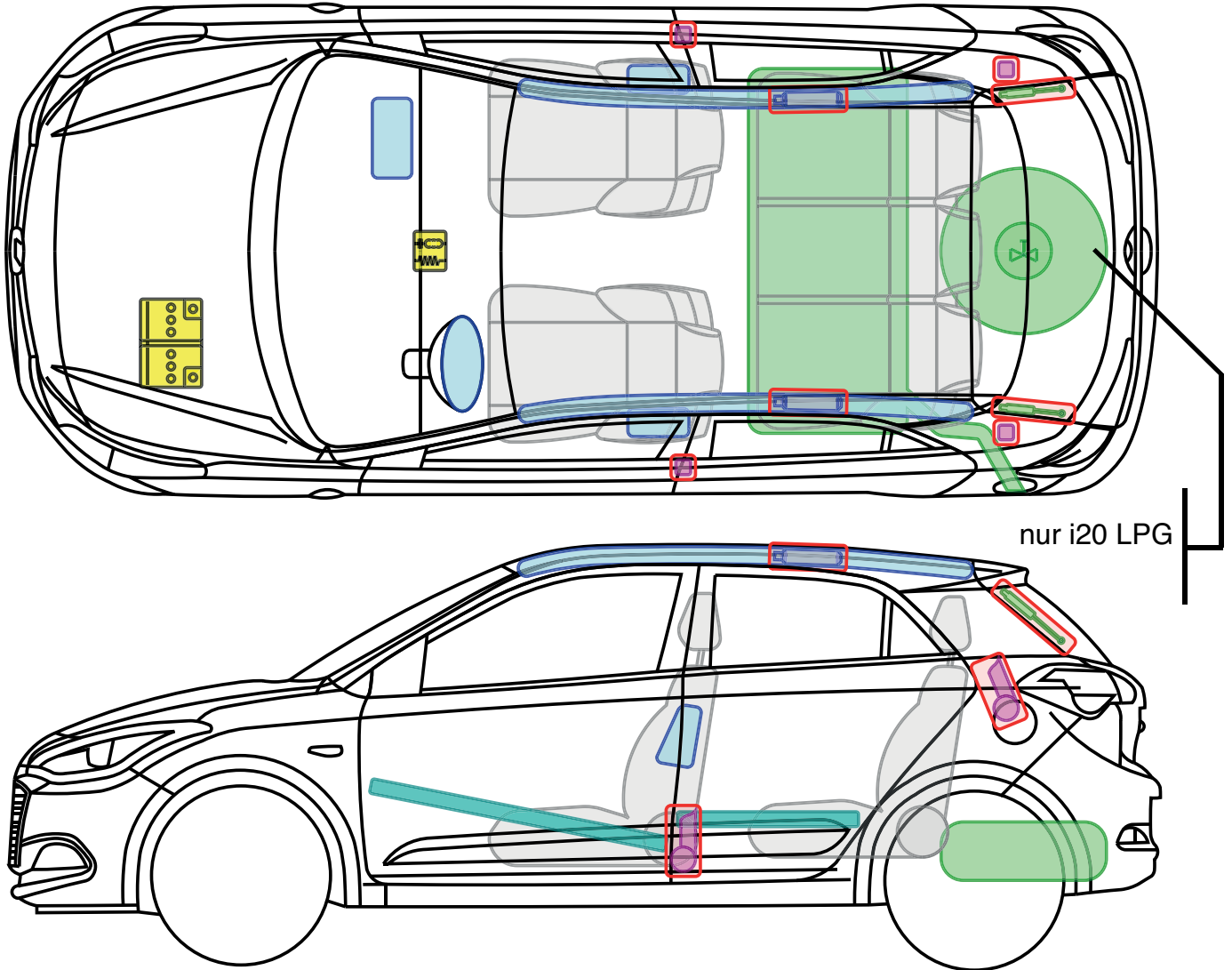

Legende

	Airbag		Karosserie- verstärkung		Steuergerät		Gastank
	Gas- generator		Überroll- schutz		12 V Batterie		Sicherheits- ventil
	Gurt- straffer		Gasdruck- dämpfer		Kraftstoff- tank		

i20

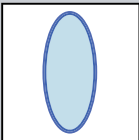
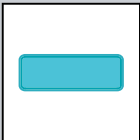

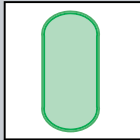
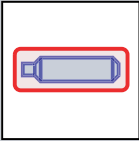
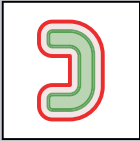
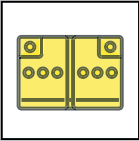
Legende

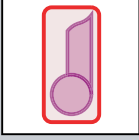
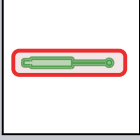
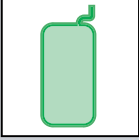

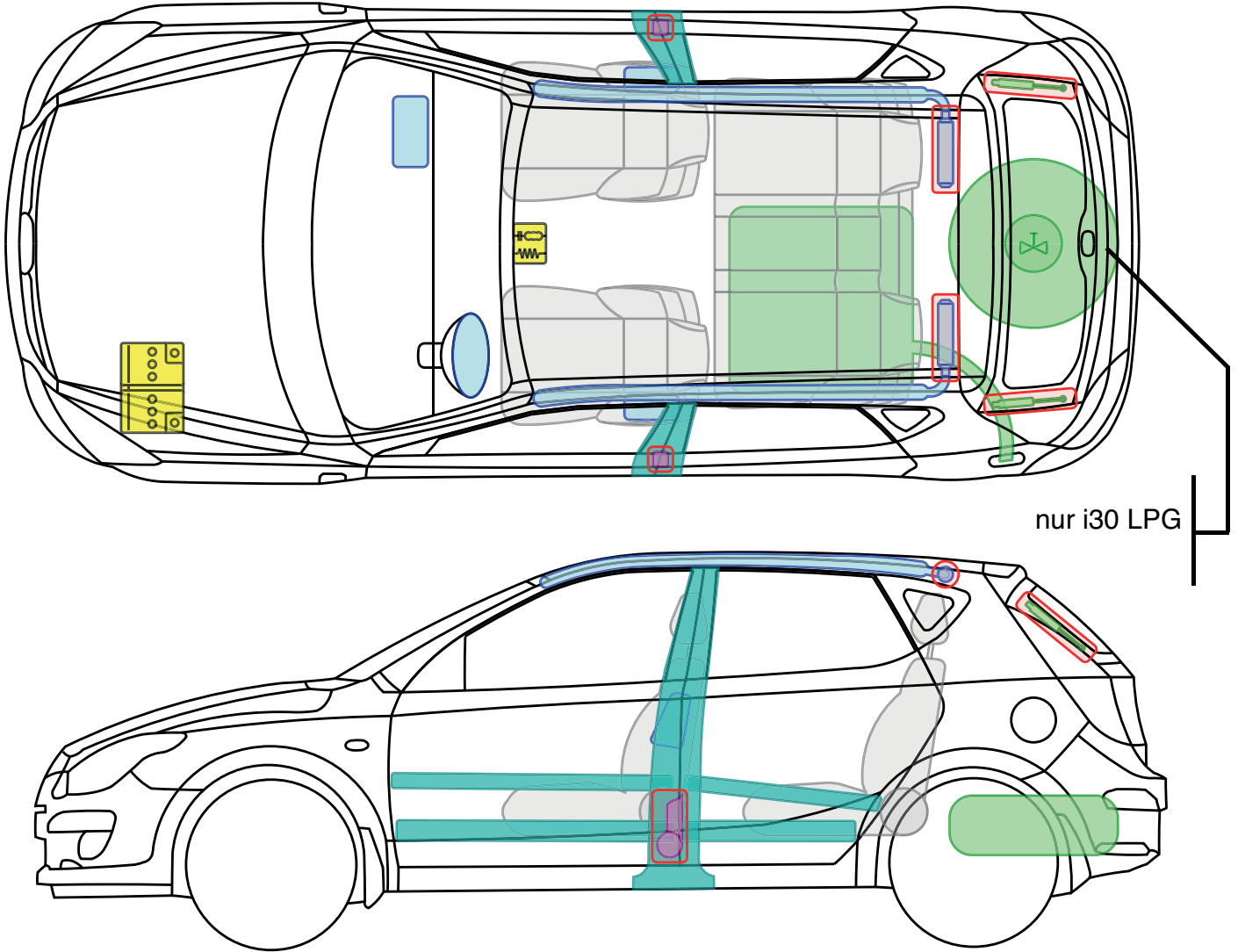

	Airbag		Karosserie- verstärkung		Steuergerät		Gastank
	Gas- generator		Überroll- schutz		12 V Batterie		Sicherheits- ventil
	Gurt- straffer		Gasdruck- dämpfer		Kraftstoff- tank		

i20

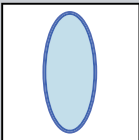
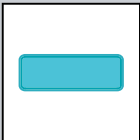

nur i30 LPG

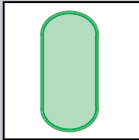
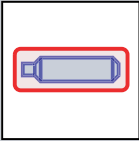
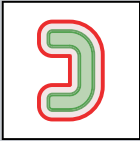
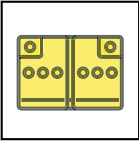
Legende

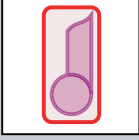
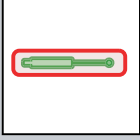
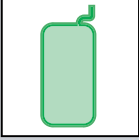

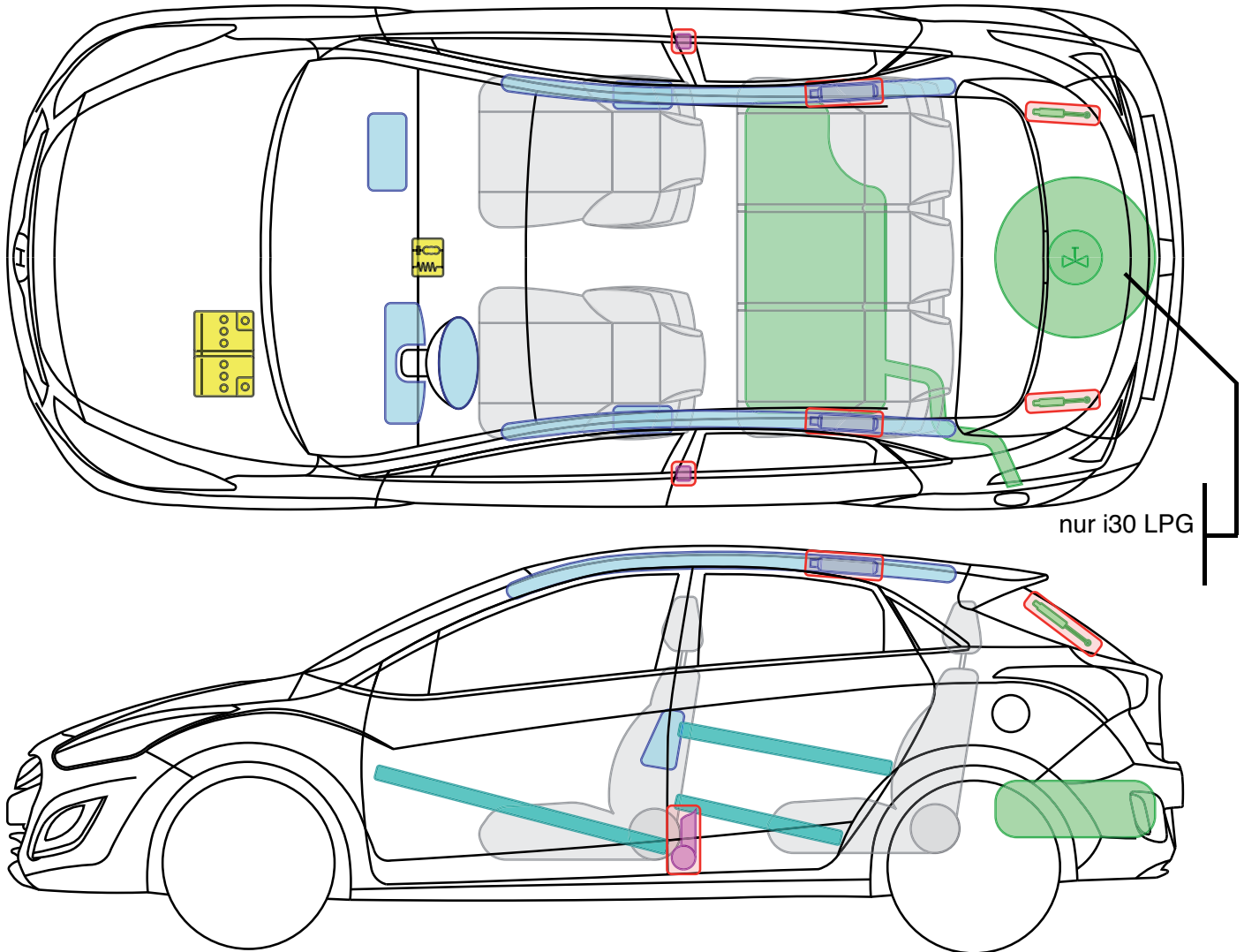

	Airbag		Karosserie- verstärkung		Steuergerät		Gastank
	Gas- generator		Überroll- schutz		12 V Batterie		Sicherheits- ventil
	Gurt- straffer		Gasdruck- dämpfer		Kraftstoff- tank		

i30

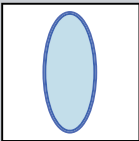
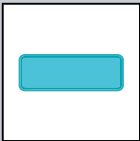

nur i30 LPG

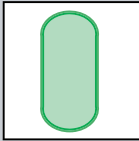
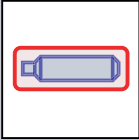
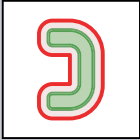
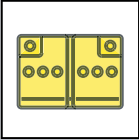

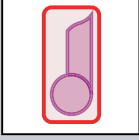
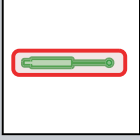
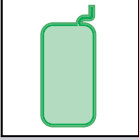

Legende

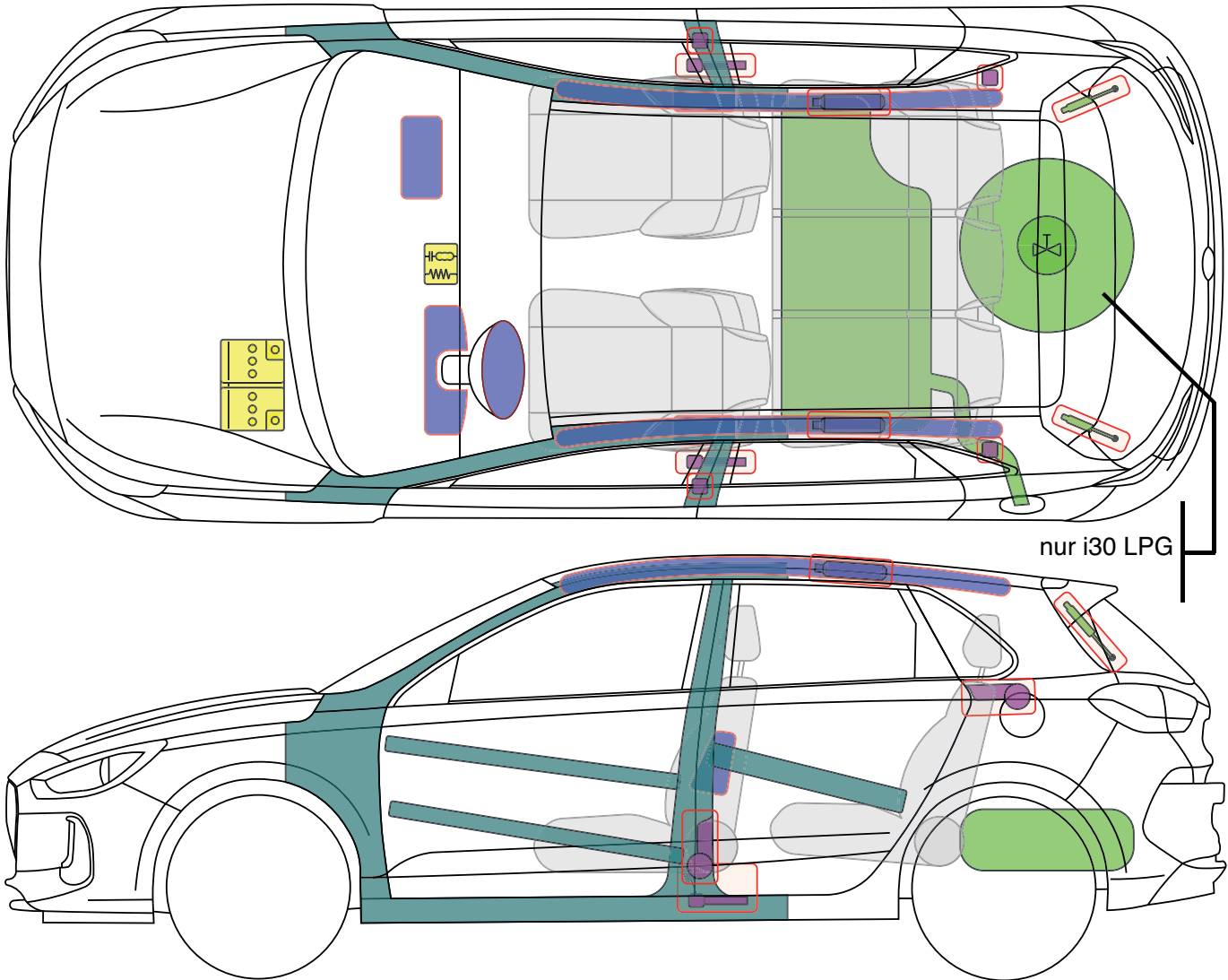
	Airbag		Karosserie- verstärkung		Steuergerät		Gastank
	Gas- generator		Überroll- schutz		12 V Batterie		Sicherheits- ventil
	Gurt- straffer		Gasdruck- dämpfer		Kraftstoff- tank		

i30

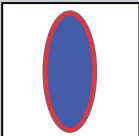
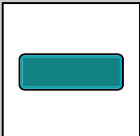
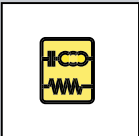
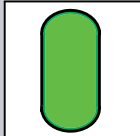
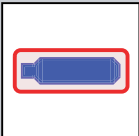
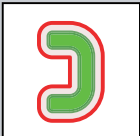
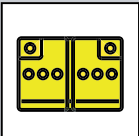

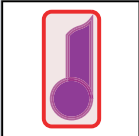
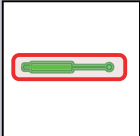
Legende



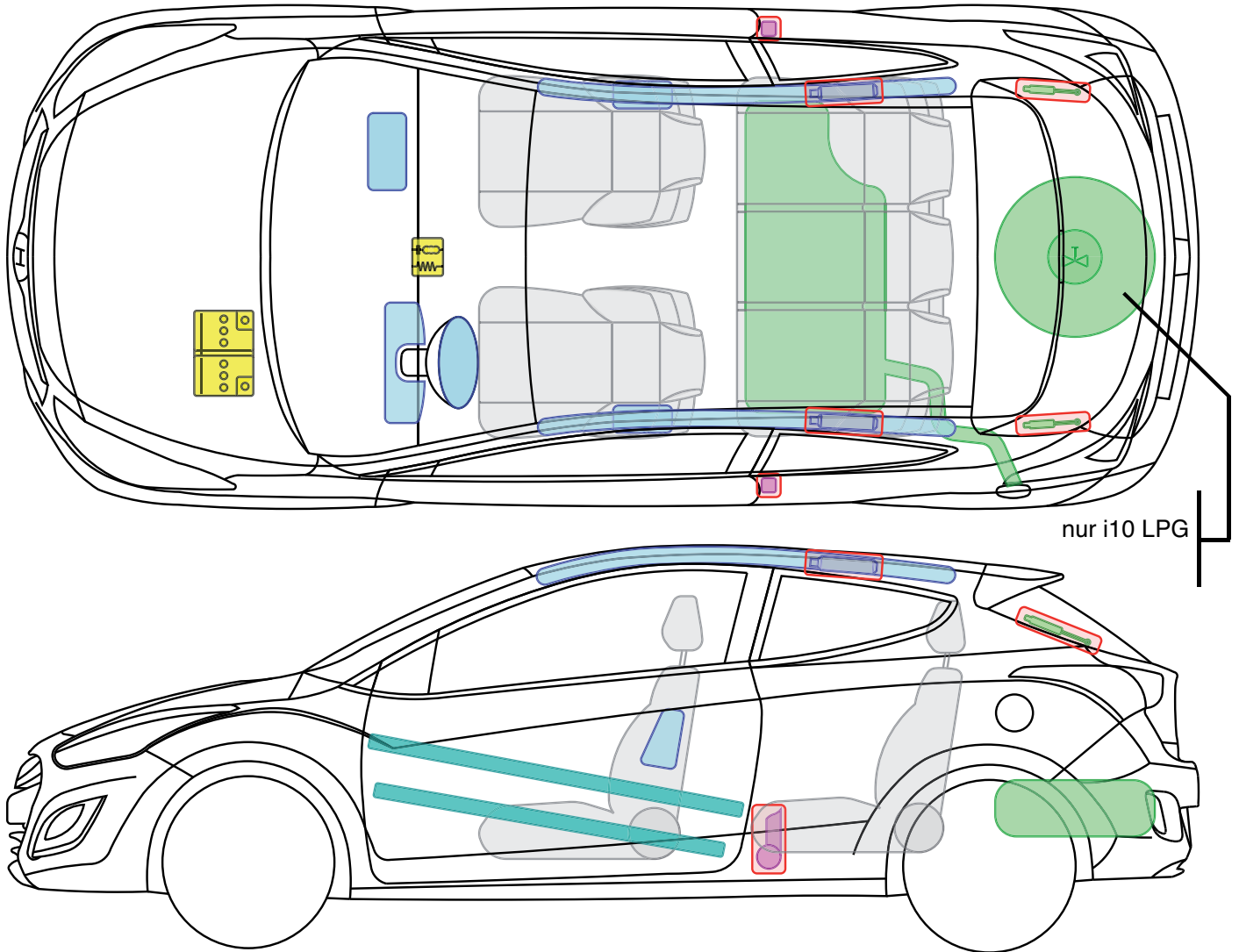

	Airbag		Karosserie- verstärkung		Steuergerät		Gastank
	Gas- generator		Überroll- schutz		12 V Batterie		Sicherheits- ventil
	Gurt- straffer		Gasdruck- dämpfer		Kraftstoff- tank		

i30

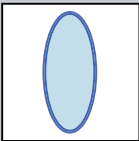
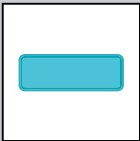

nur i10 LPG

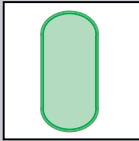
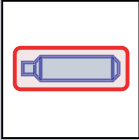
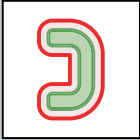
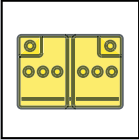

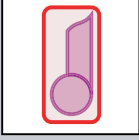
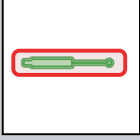
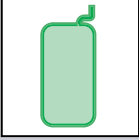

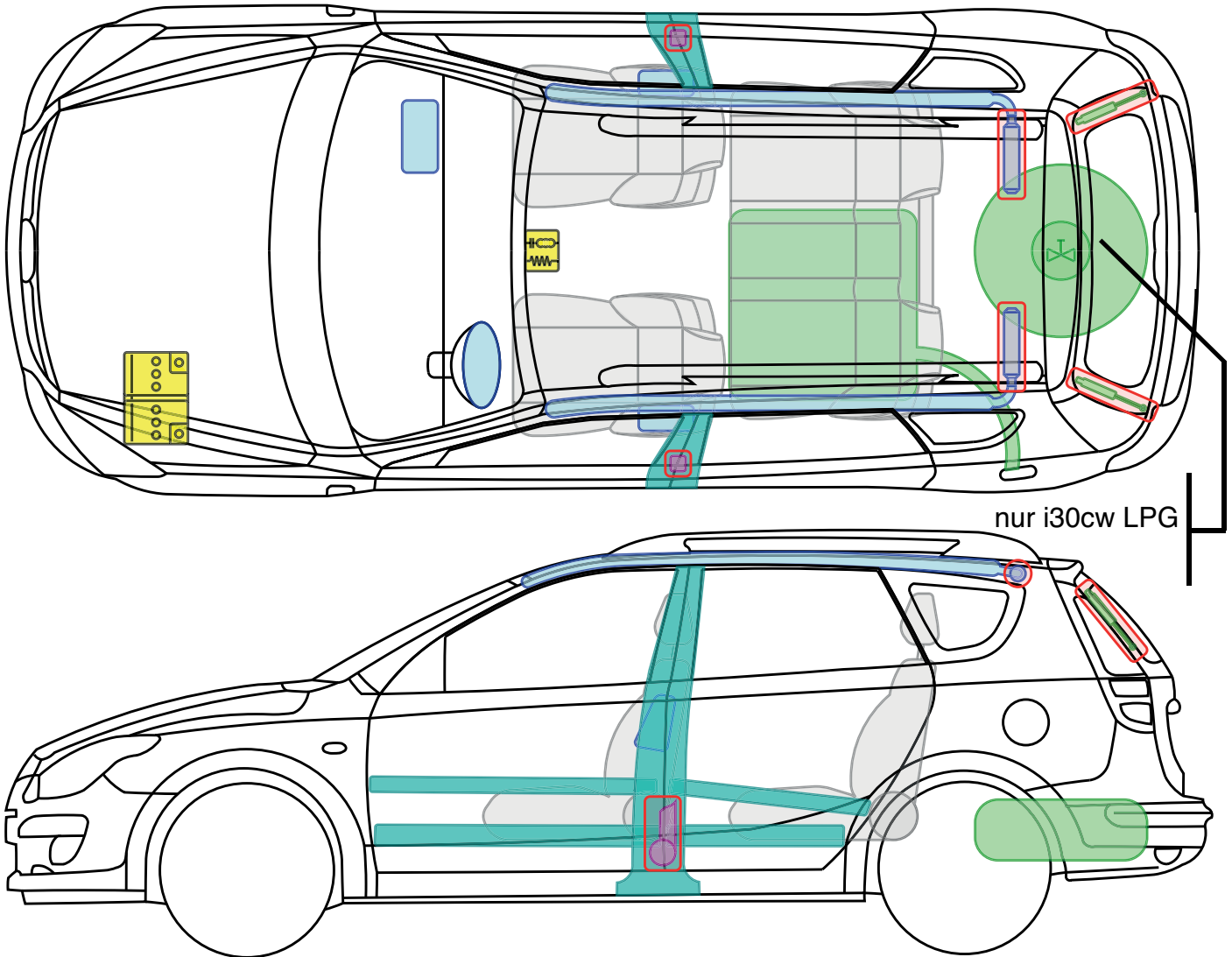

Legende

	Airbag		Karosserie- verstärkung		Steuergerät		Gastank
	Gas- generator		Überroll- schutz		12 V Batterie		Sicherheits- ventil
	Gurt- straffer		Gasdruck- dämpfer		Kraftstoff- tank		

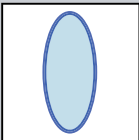
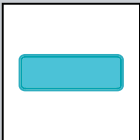
i30 Coupe

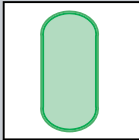
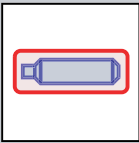
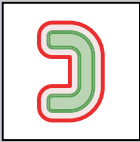
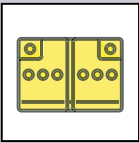

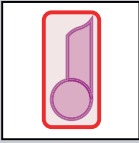
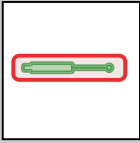

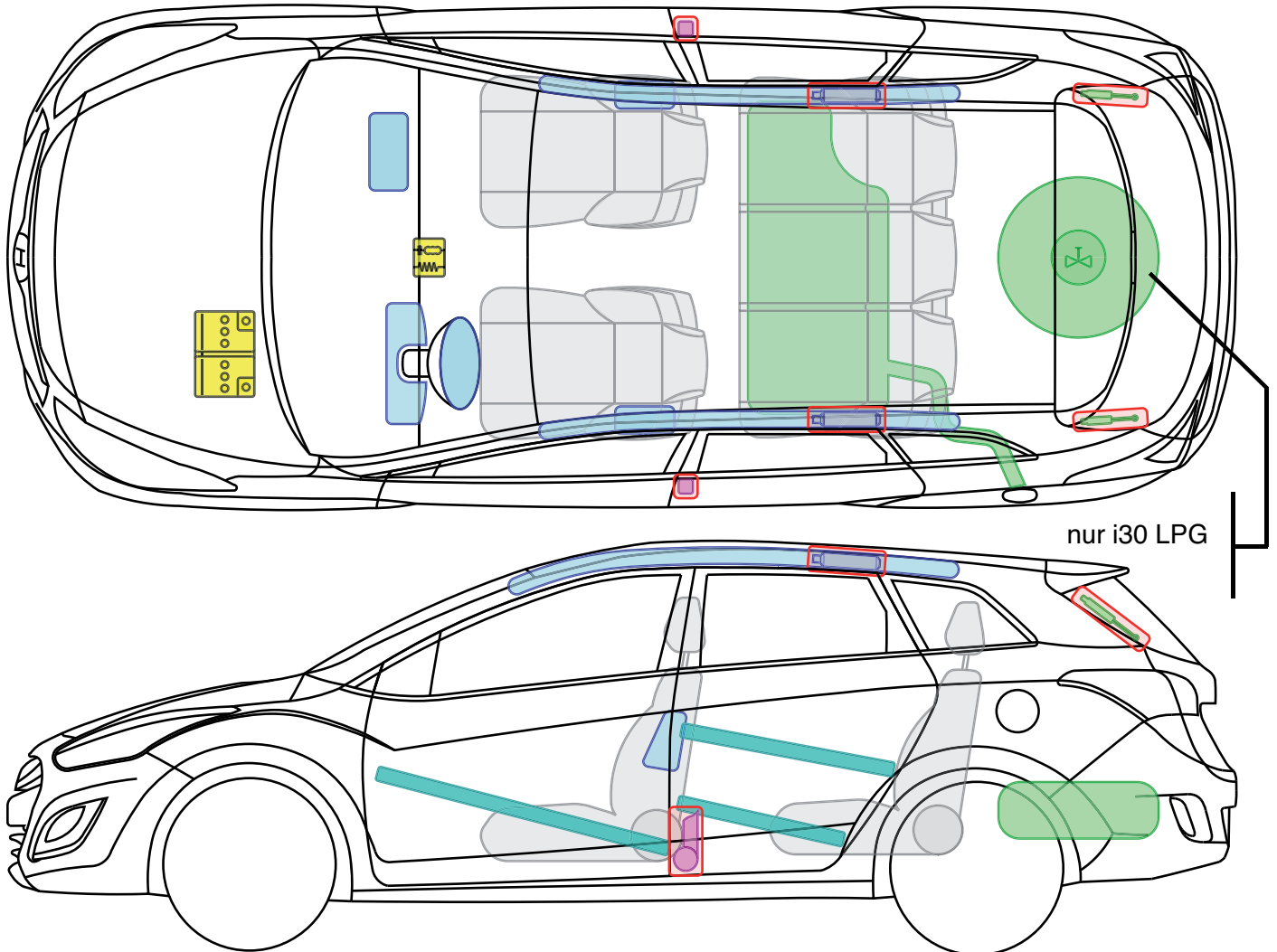

Legende

	Airbag		Karosserie- verstärkung		Steuergerät		Gastank
	Gas- generator		Überroll- schutz		12 V Batterie		Sicherheits- ventil
	Gurt- straffer		Gasdruck- dämpfer		Kraftstoff- tank		

i30cw

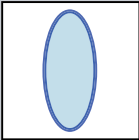
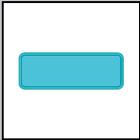

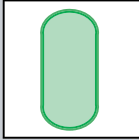
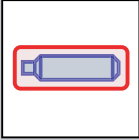
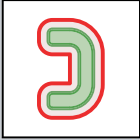
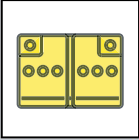

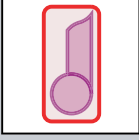
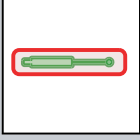
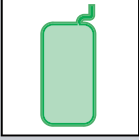

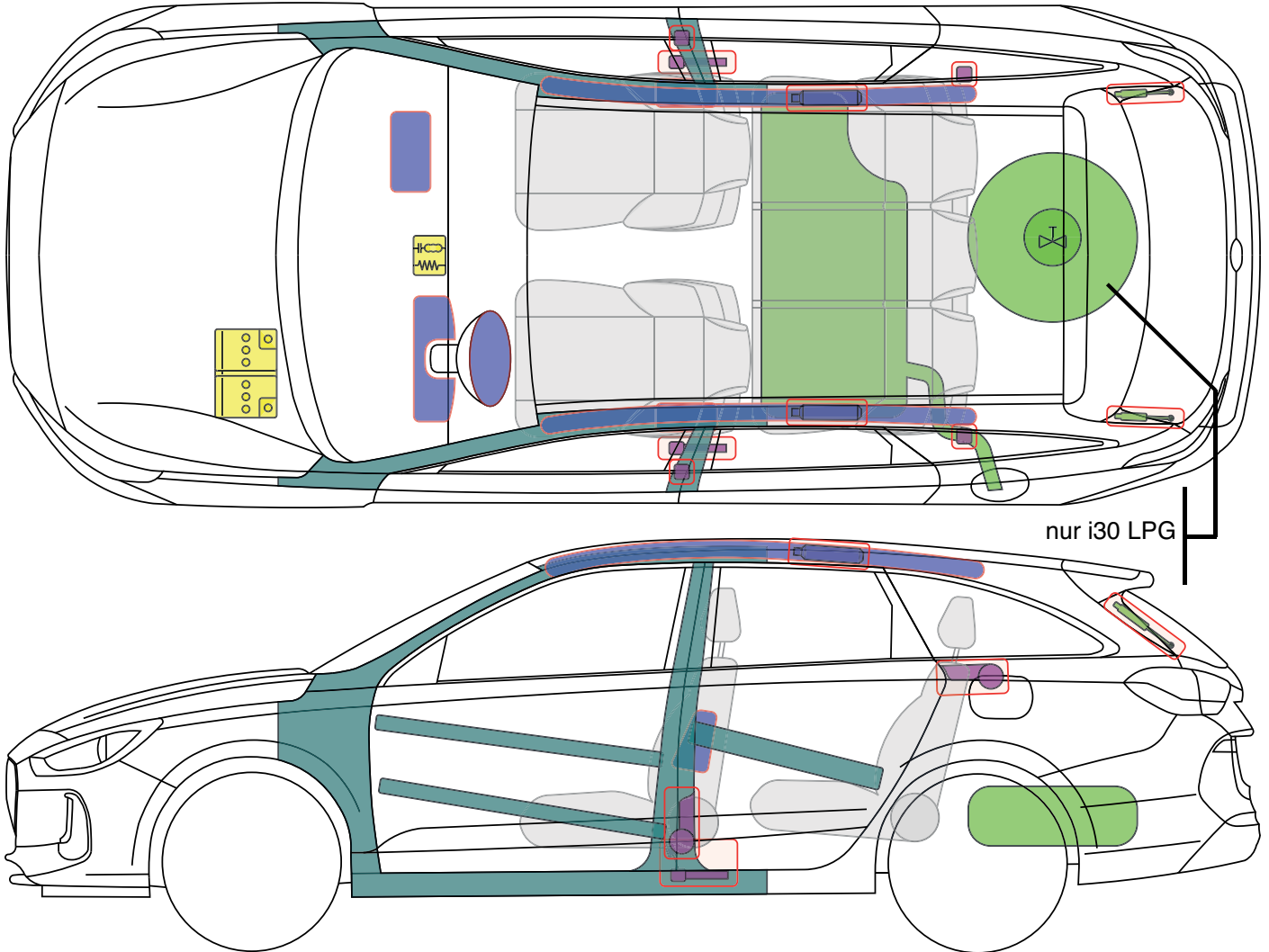

Legende

	Airbag		Karosserie- verstärkung		Steuergerät		Gastank
	Gas- generator		Überroll- schutz		12 V Batterie		Sicherheits- ventil
	Gurt- straffer		Gasdruck- dämpfer		Kraftstoff- tank		

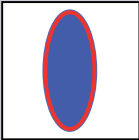
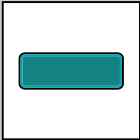
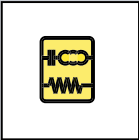
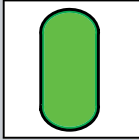
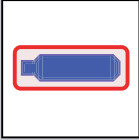
i30cw

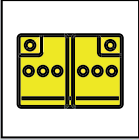

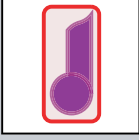
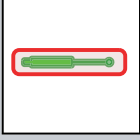

Legende

	Airbag		Karosserie- verstärkung		Steuergerät		Gastank
	Gas- generator		Überroll- schutz		12 V Batterie		Sicherheits- ventil
	Gurt- straffer		Gasdruck- dämpfer		Kraftstoff- tank		

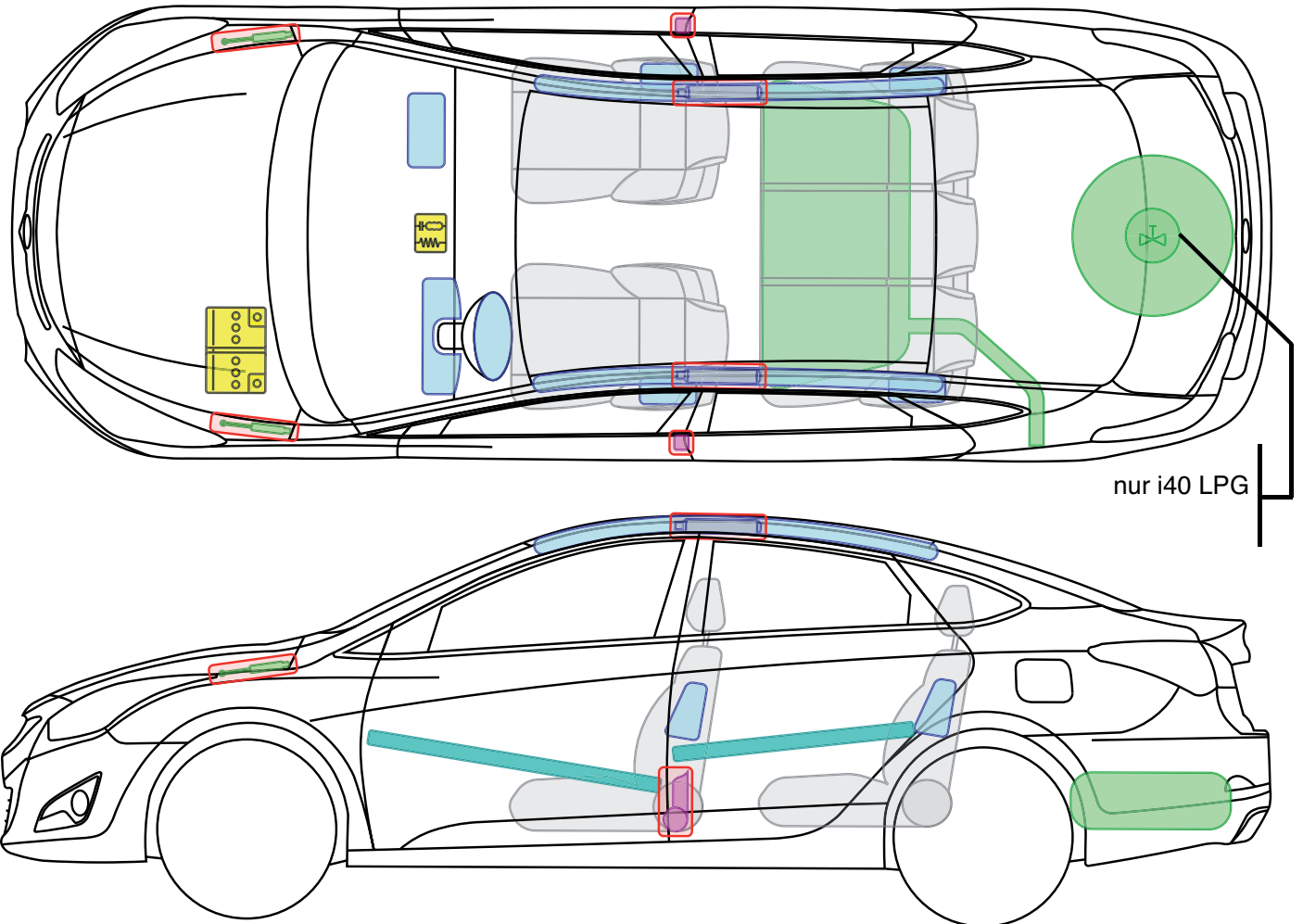
i30cw

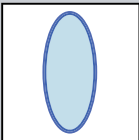
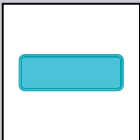

Legende

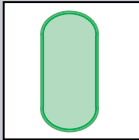
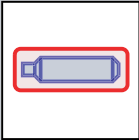
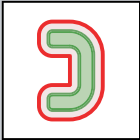
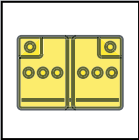
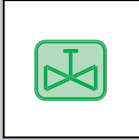
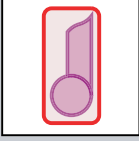
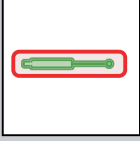
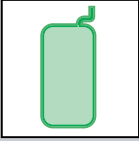

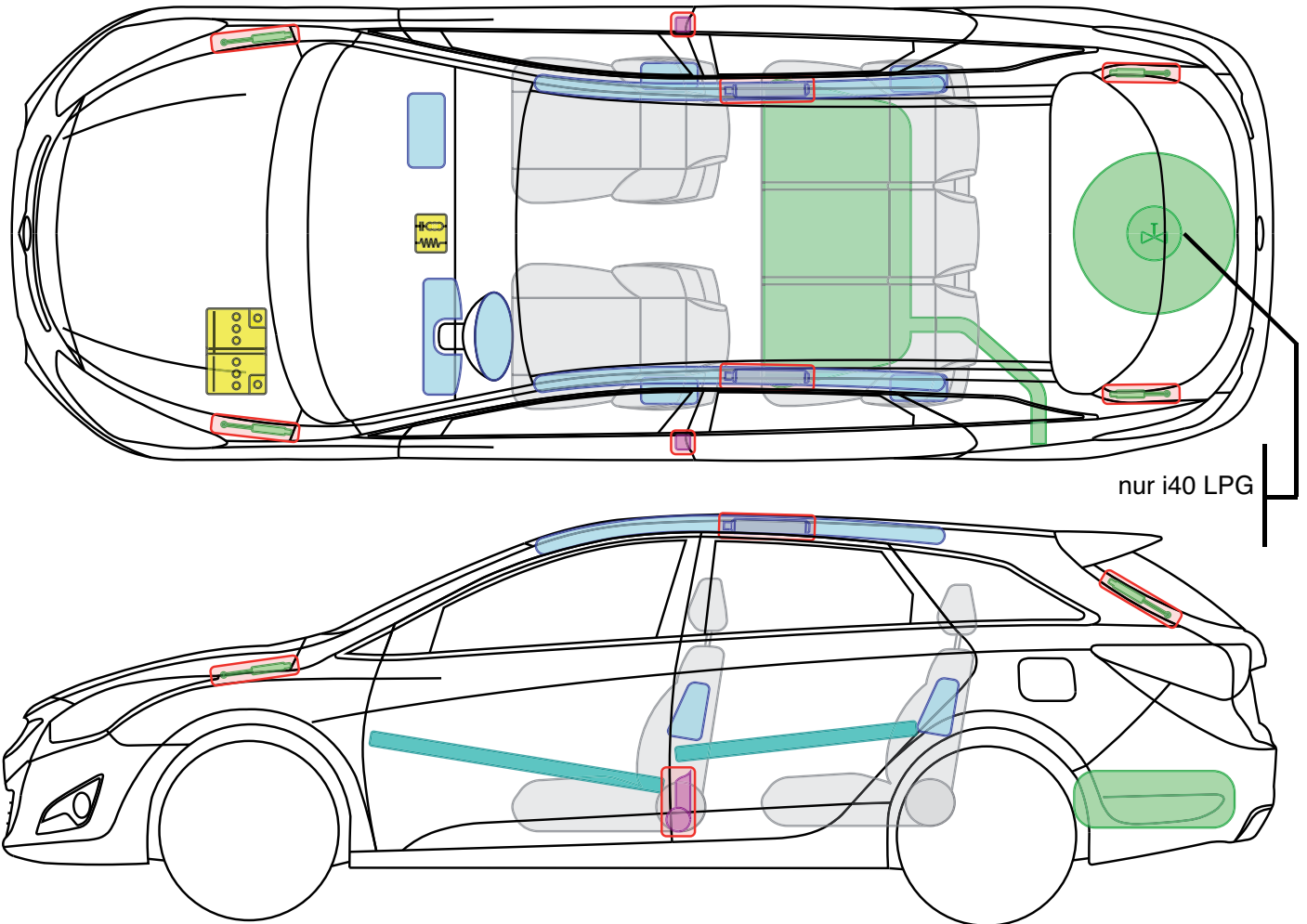

	Airbag		Karosserie- verstärkung		Steuergerät		Gastank
	Gas- generator		Überroll- schutz		12 V Batterie		Sicherheits- ventil
	Gurt- straffer		Gasdruck- dämpfer		Kraftstoff- tank		

i40

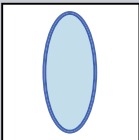
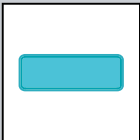

nur i40 LPG

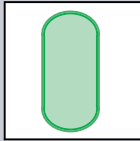
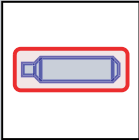
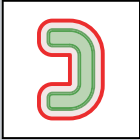
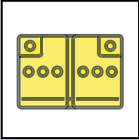

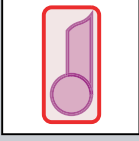
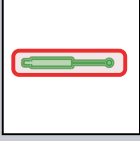
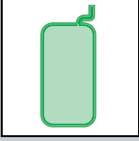

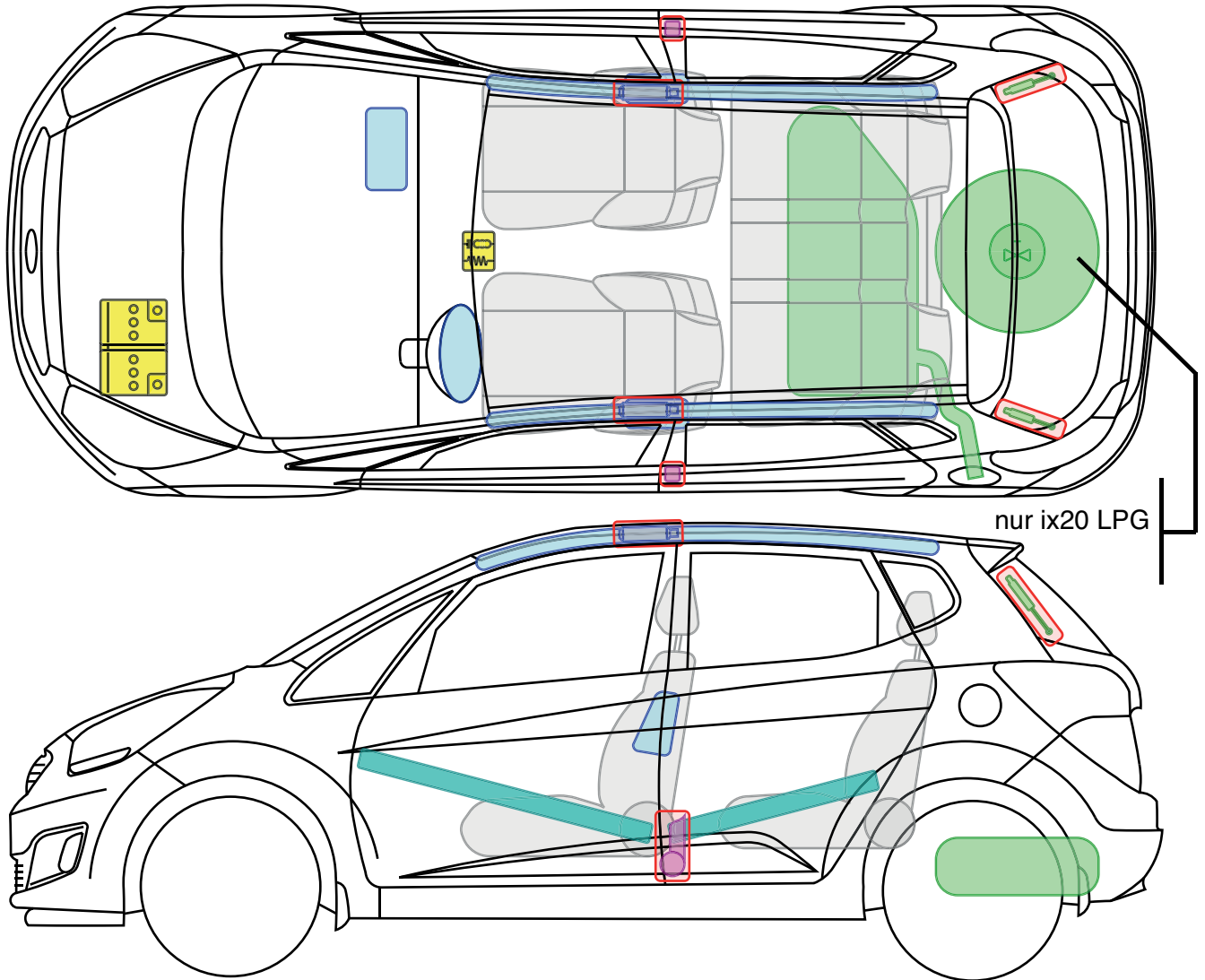

Legende

	Airbag		Karosserie- verstärkung		Steuergerät		Gastank
	Gas- generator		Überroll- schutz		12 V Batterie		Sicherheits- ventil
	Gurt- straffer		Gasdruck- dämpfer		Kraftstoff- tank		

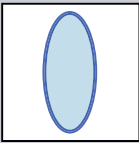
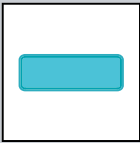
i40

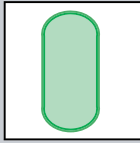
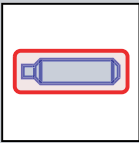
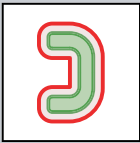
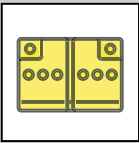

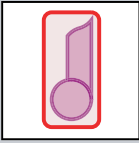
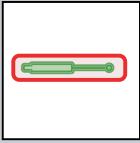



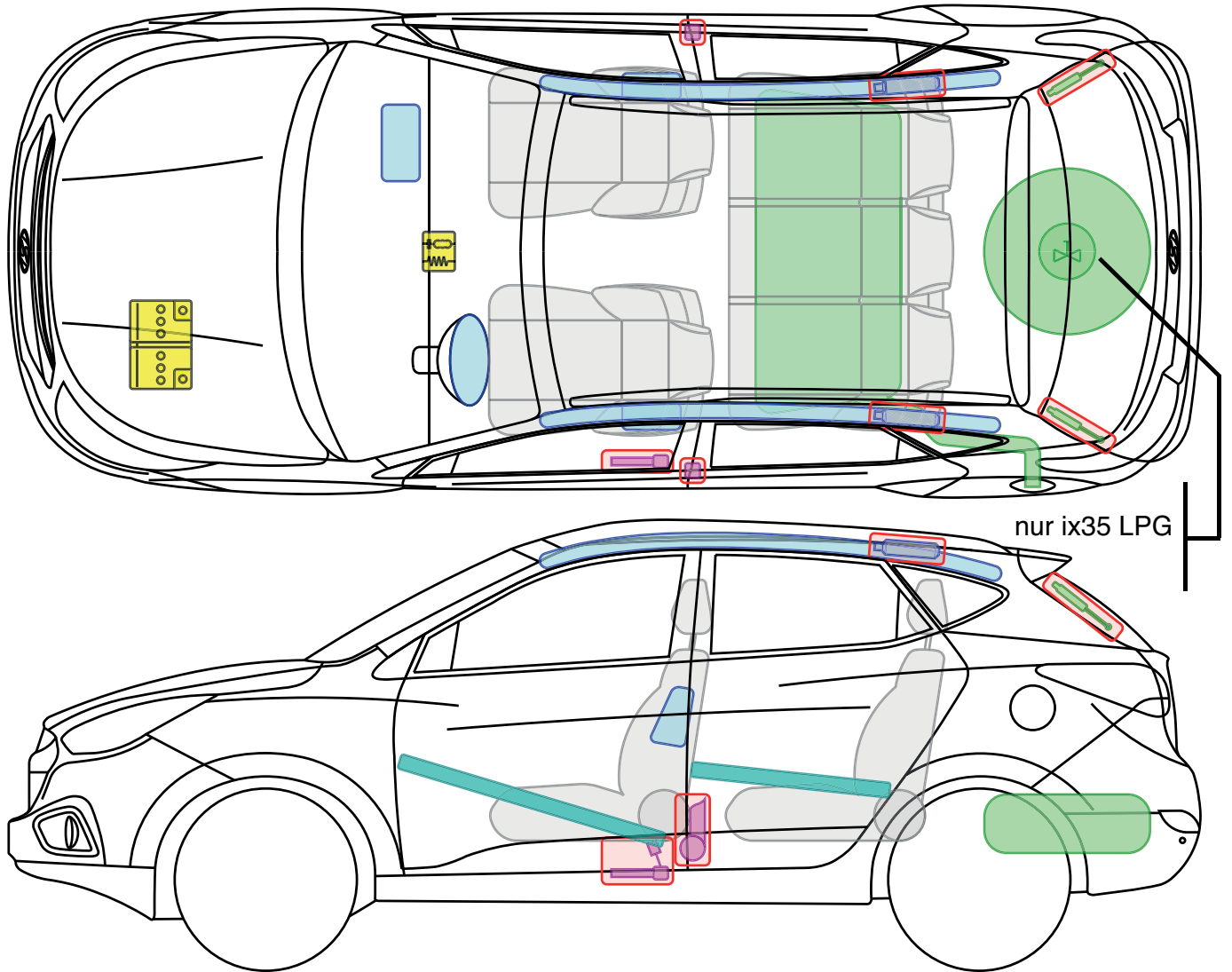

Legende

	Airbag		Karosserie- verstärkung		Steuergerät		Gastank
	Gas- generator		Überroll- schutz		12 V Batterie		Sicherheits- ventil
	Gurt- straffer		Gasdruck- dämpfer		Kraftstoff- tank		

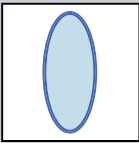
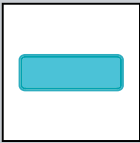
ix20

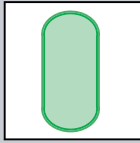
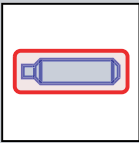
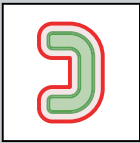
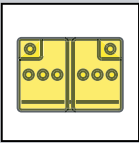

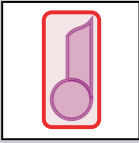
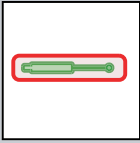





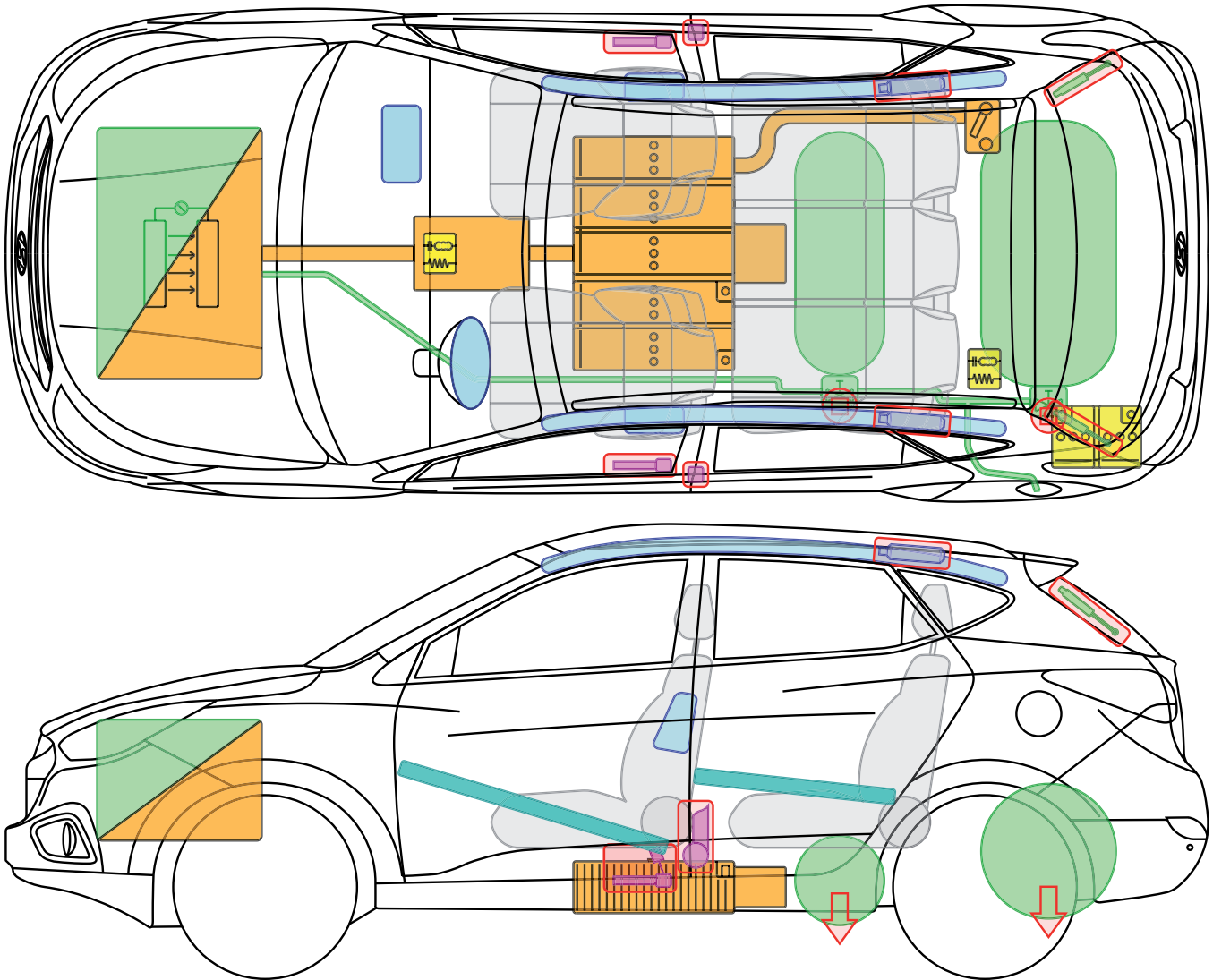



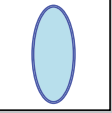

Legende

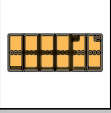
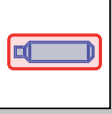
	Airbag		Karosserie- verstärkung		Steuergerät		Gastank
	Gas- generator		Überroll- schutz		12 V Batterie		Sicherheits- ventil
	Gurt- straffer		Gasdruck- dämpfer		Kraftstoff- tank		

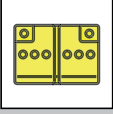
ix35

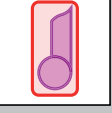
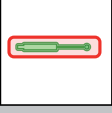

Legende

	Airbag		Karosserie- verstärkung		Steuergerät		Sicherheits- ventil		Hochvolt- batterie
	Gas- generator		Überroll- schutz		12 V Batterie		Brennstoff- zelle		Hochvolt -leitung/ -komponente
	Gurt- straffer		Gasdruck- dämpfer		Kraftstoff- tank		Abblas- richtung		Notfalltrenn- stelle

ix35 FCEV



Allgemeine Hinweise

- Fahrzeug mit elektrischem Brennstoffzellen-System.
Druckwasserstoffspeicherung.
- Initialer Sicherheitsabstand: **50 m**
- Bereich der **Wasserstoff-Abblaseinrichtung** freihalten (rote Pfeile).
- Hochvoltkomponenten sind mit Warnaufklebern gekennzeichnet.
- Hochvoltkabel verfügen über eine orangefarbene Isolierung.
- Wasserstofftanks verfügen über elektromagnetische Absperrventile, manuelles Schließen nicht möglich.
- Hochvolt- und Wasserstoffsystem werden bei Unfällen mit Airbagauslösung i.d.R. automatisch abgeschaltet.
- Fahrzeug wie angegeben deaktivieren.

Fahrzeug immobilisieren und deaktivieren

- Gangwahlhebel in Stellung „P“ bringen
- Feststellbremse betätigen.
- Bei eingeschalteter Zündung:
 1. Bremspedal nicht betätigen
 2. Start-Stop Knopf einmal betätigen



- 12 Volt Batterie abklemmen







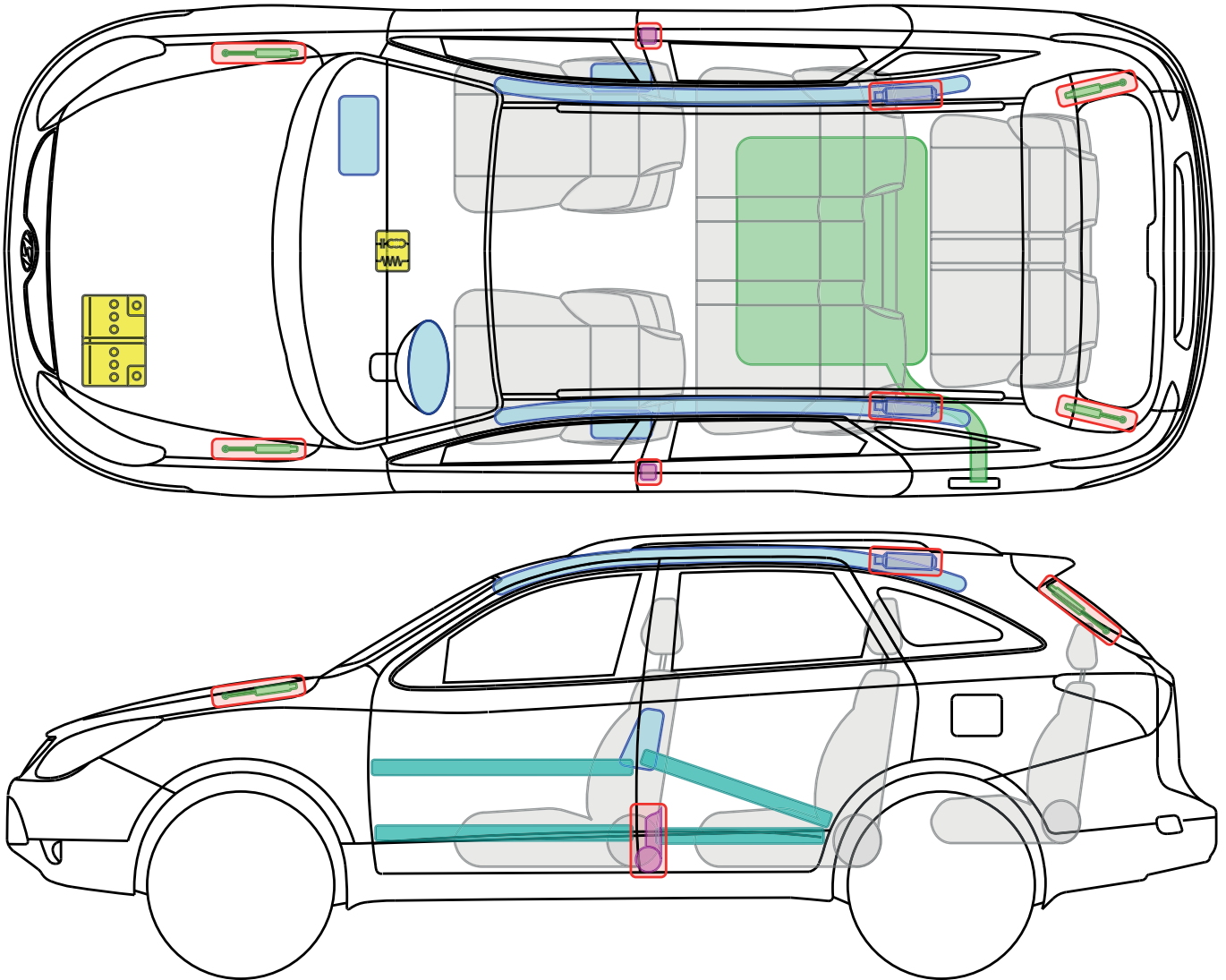

- Service Disconnect Stecker entfernen
(isolierende Schutzhandschuhe bis 1000V erforderlich)

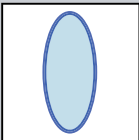
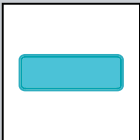

ix35 FCEV

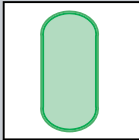
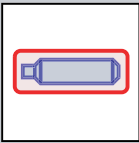
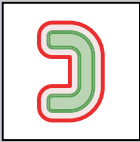
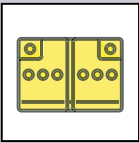

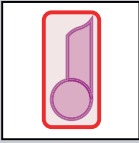
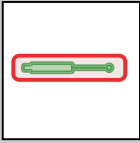





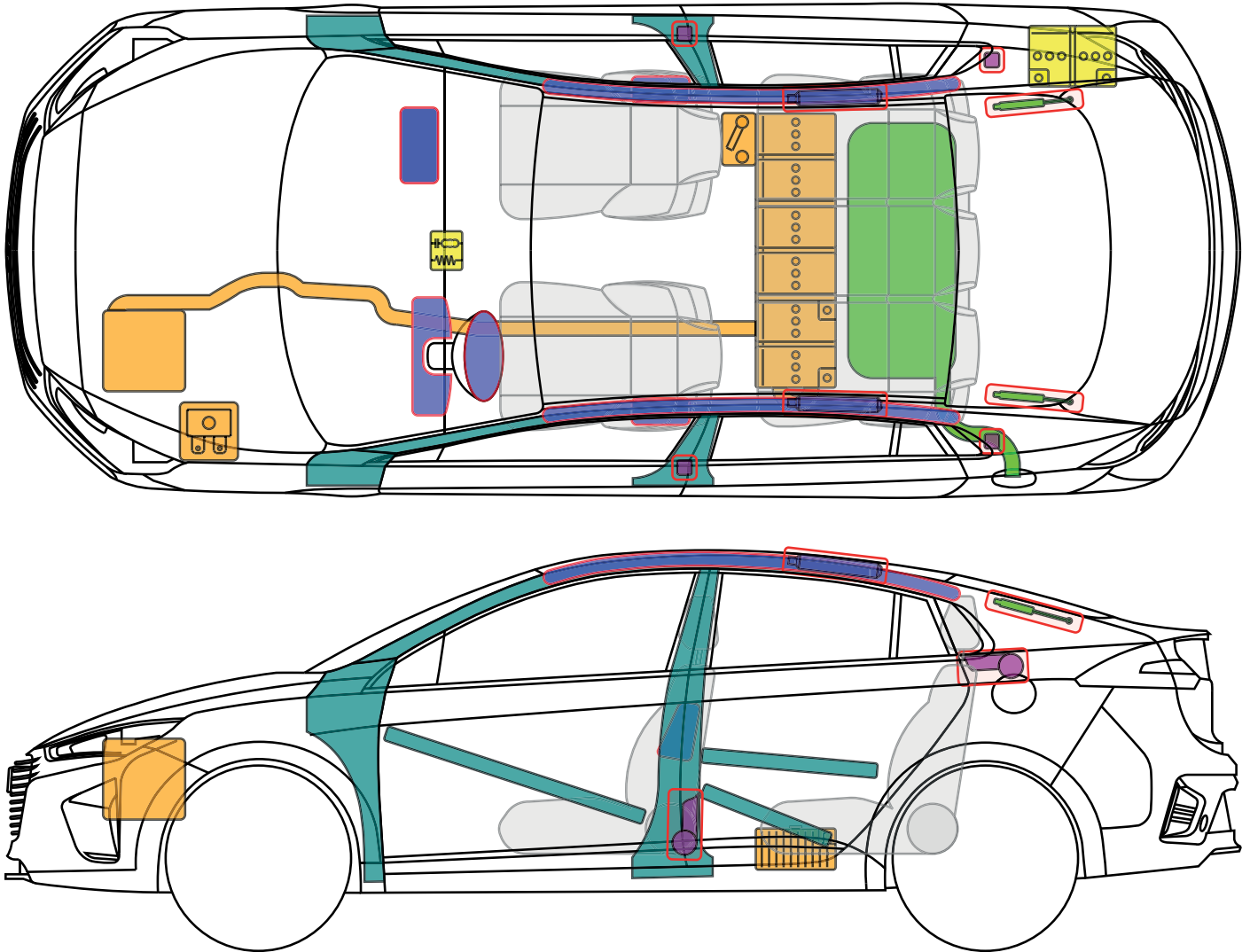



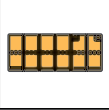
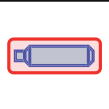

Legende

	Airbag		Karosserie- verstärkung		Steuergerät		Gastank
	Gas- generator		Überroll- schutz		12 V Batterie		Sicherheits- ventil
	Gurt- straffer		Gasdruck- dämpfer		Kraftstoff- tank		

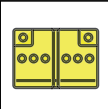
ix55

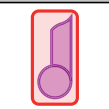
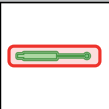







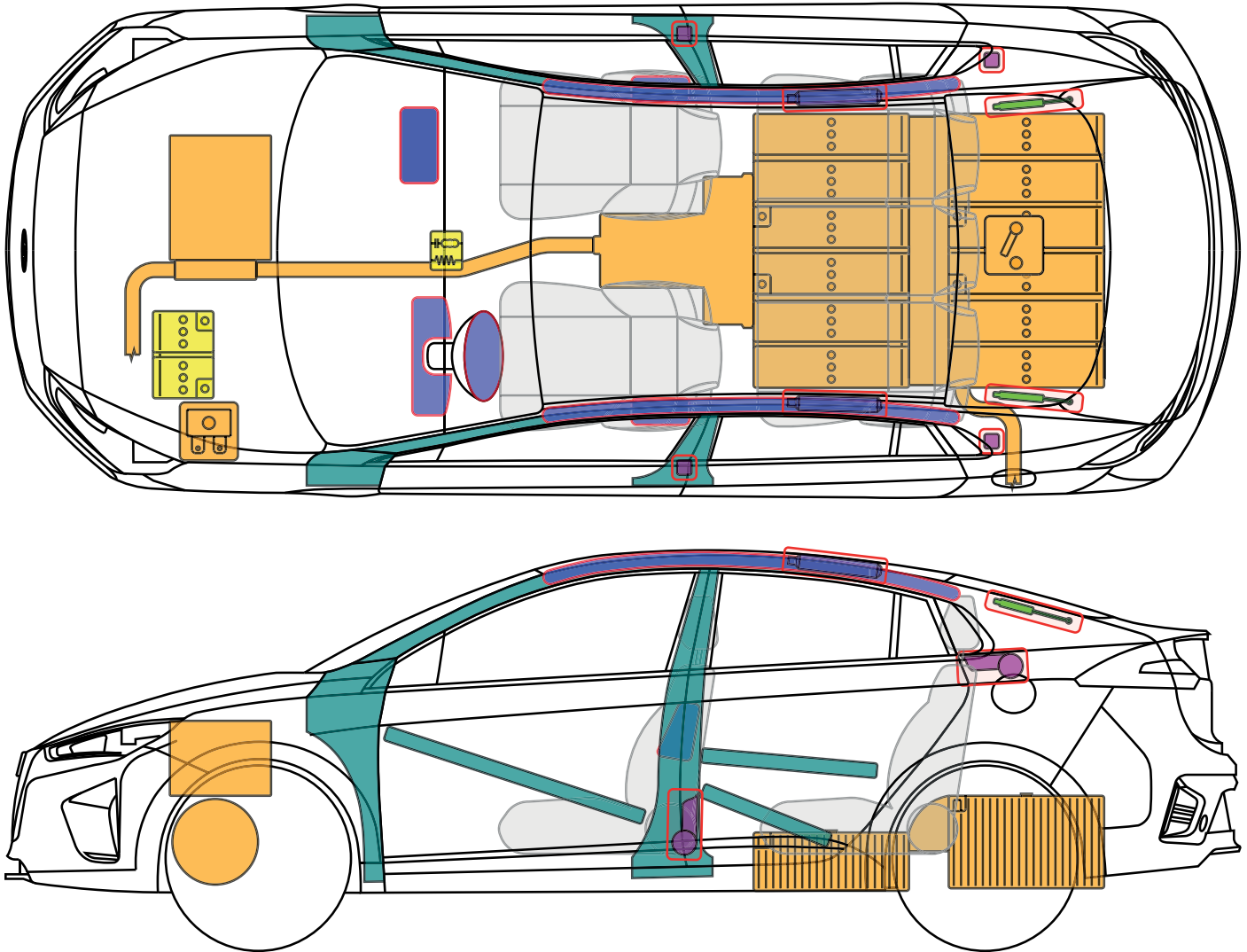



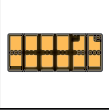
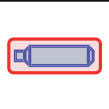

Legende

	Airbag		Karosserie- verstärkung		Steuergerät		Sicherheits- ventil		Hochvolt- batterie
	Gas- generator		Überroll- schutz		12 V Batterie		Brennstoff- zelle		Hochvolt -leitung/ -komponente
	Gurt- straffer		Gasdruck- dämpfer		Kraftstoff- tank		Abblas- richtung		Notfalltrenn- stelle

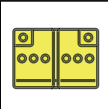
Ioniq Hybrid

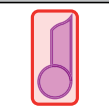
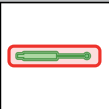







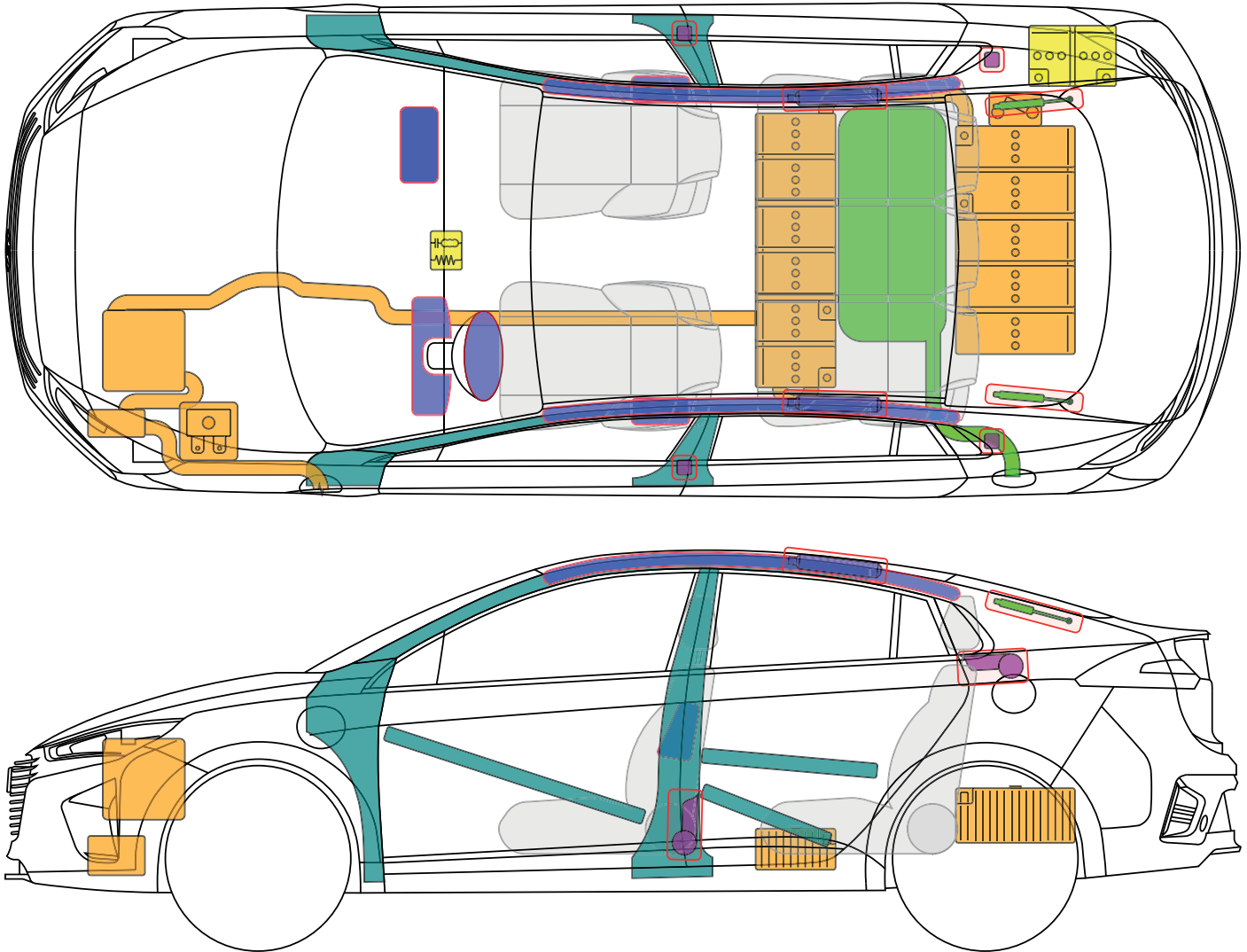

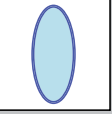

Legende

	Airbag		Karosserie- verstärkung		Steuergerät		Sicherheits- ventil		Hochvolt- batterie
	Gas- generator		Überroll- schutz		12 V Batterie		Brennstoff- zelle		Hochvolt -leitung/ -komponente
	Gurt- straffer		Gasdruck- dämpfer		Kraftstoff- tank		Abblas- richtung		Notfalltrenn- stelle

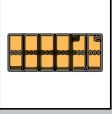
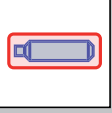
Ioniq Elektro

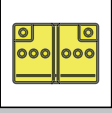

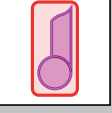
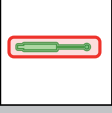
Legende

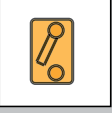
	Airbag		Karosserie- verstärkung		Steuergerät		Sicherheits- ventil		Hochvolt- batterie
	Gas- generator		Überroll- schutz		12 V Batterie		Brennstoff- zelle		Hochvolt -leitung/ -komponente
	Gurt- straffer		Gasdruck- dämpfer		Kraftstoff- tank		Abblas- richtung		Notfalltrenn- stelle



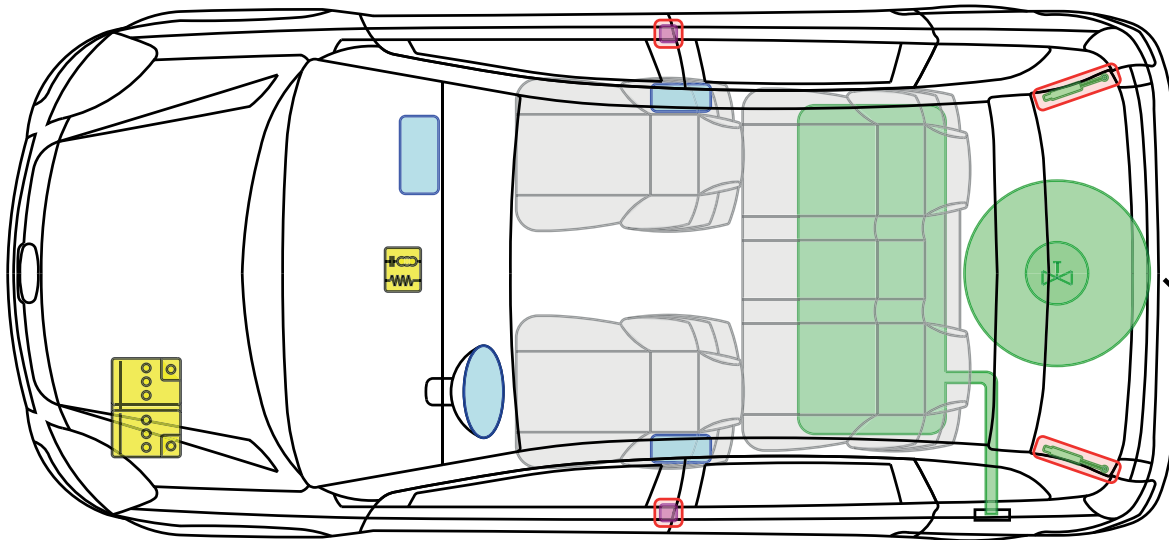

Ioniq Plug-in Hybrid

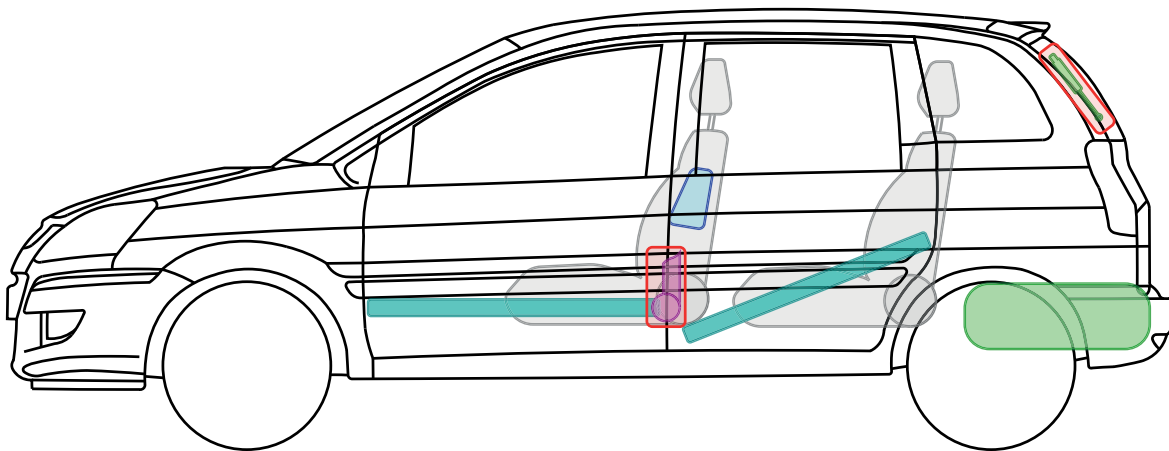

nur Matrix LPG

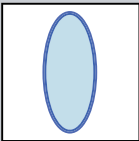
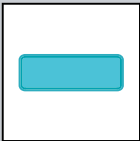

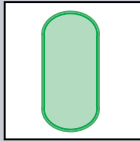
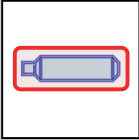
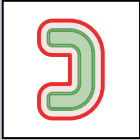
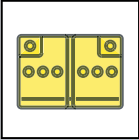

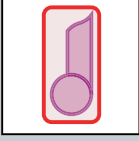
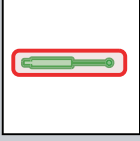
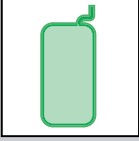

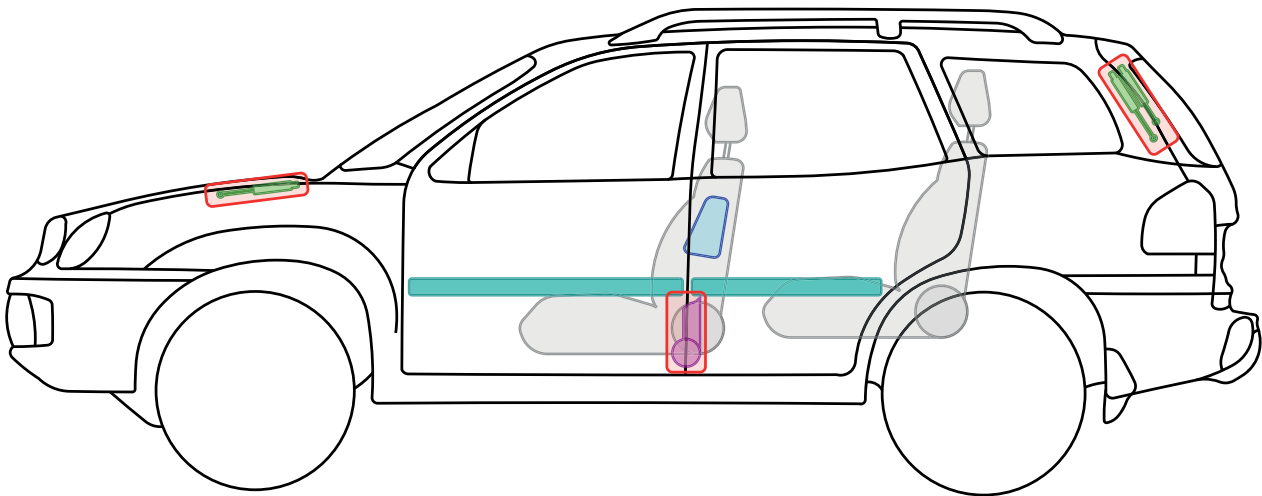
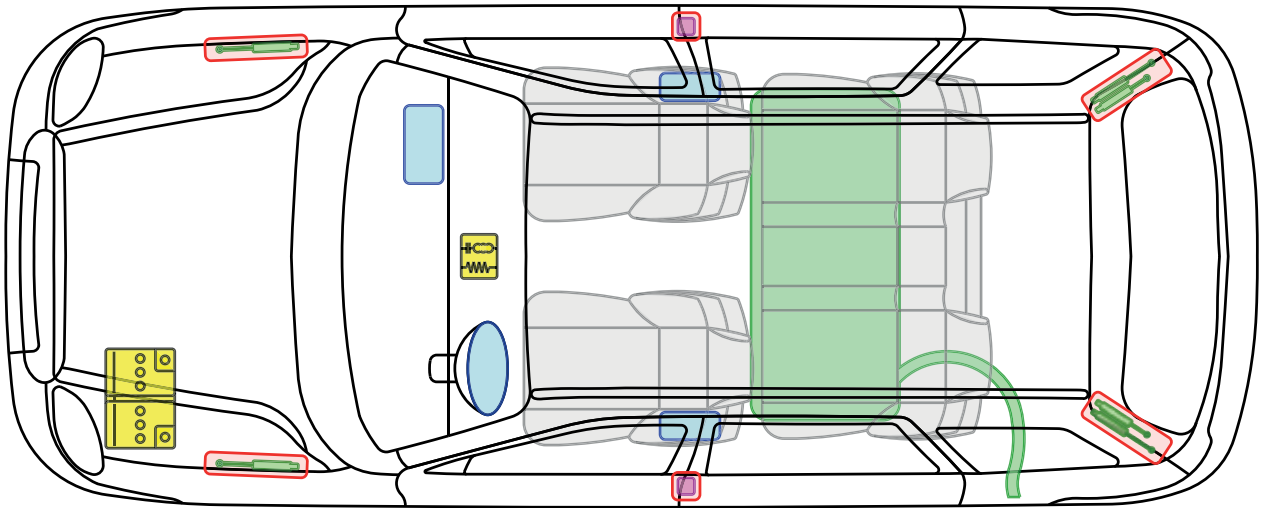

Legende

	Airbag		Karosserie- verstärkung		Steuergerät		Gastank
	Gas- generator		Überroll- schutz		12 V Batterie		Sicherheits- ventil
	Gurt- straffer		Gasdruck- dämpfer		Kraftstoff- tank		

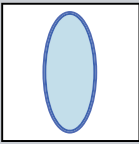
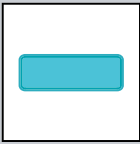
Matrix

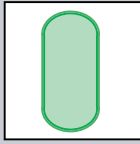
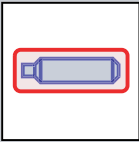
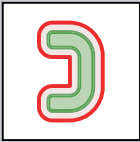
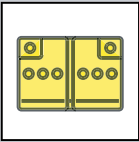

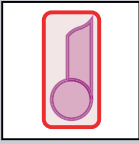
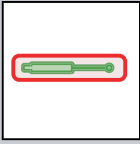

Legende

	Airbag		Karosserie- verstärkung		Steuergerät		Gastank
	Gas- generator		Überroll- schutz		12 V Batterie		Sicherheits- ventil
	Gurt- straffer		Gasdruck- dämpfer		Kraftstoff- tank		

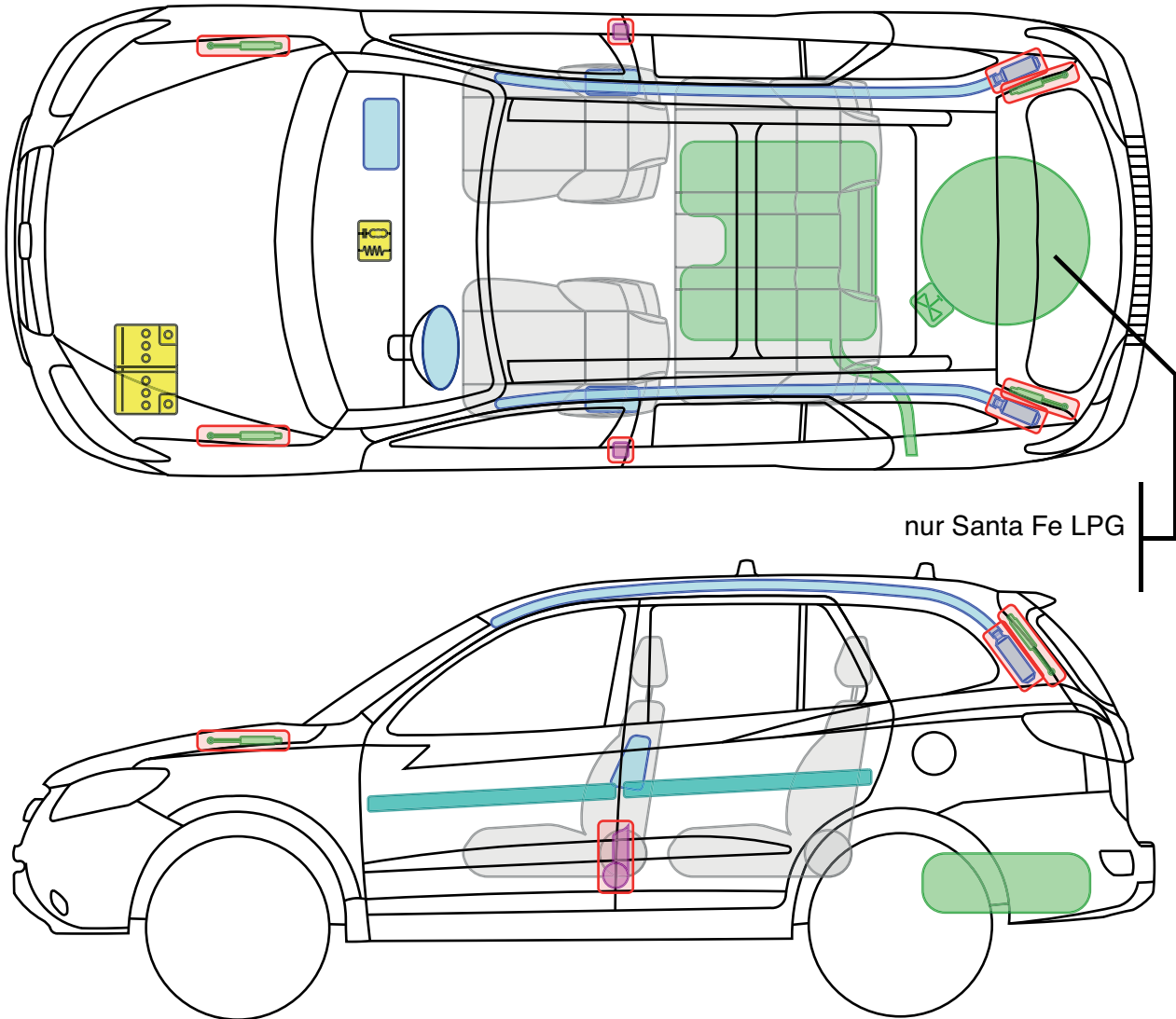
Santa Fe

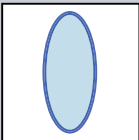
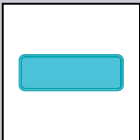

Legende

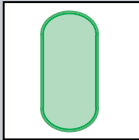
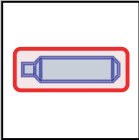
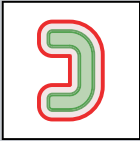
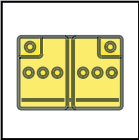
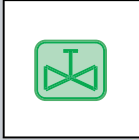
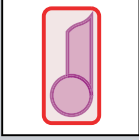
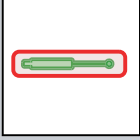
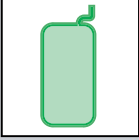
	Airbag		Karosserie- verstärkung		Steuergerät		Gastank
	Gas- generator		Überroll- schutz		12 V Batterie		Sicherheits- ventil
	Gurt- straffer		Gasdruck- dämpfer		Kraftstoff- tank		

Santa Fe



(Grand) Santa Fe
5-Türer
 (Typ DM/NC, ab 2012)

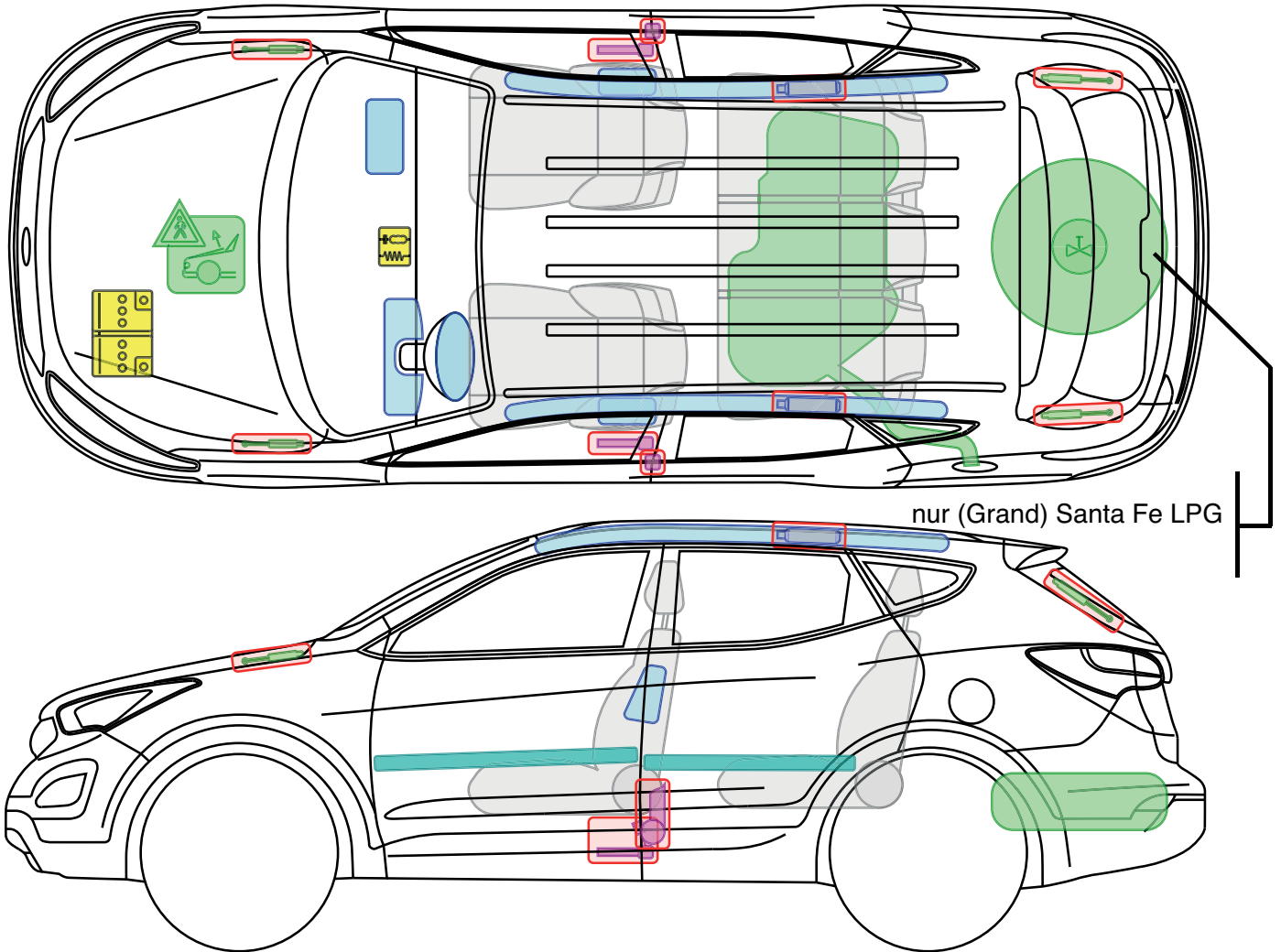



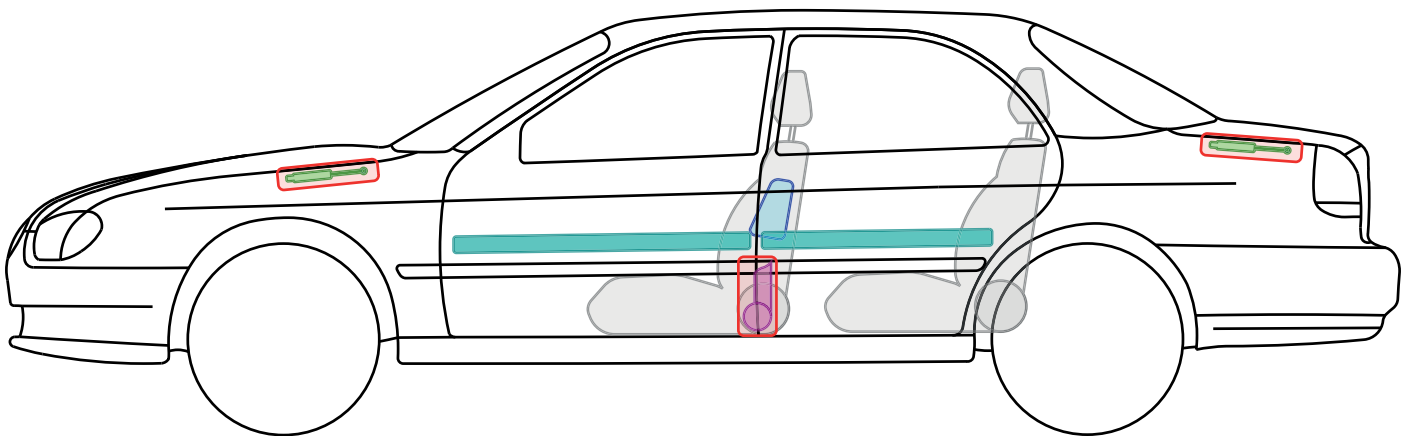
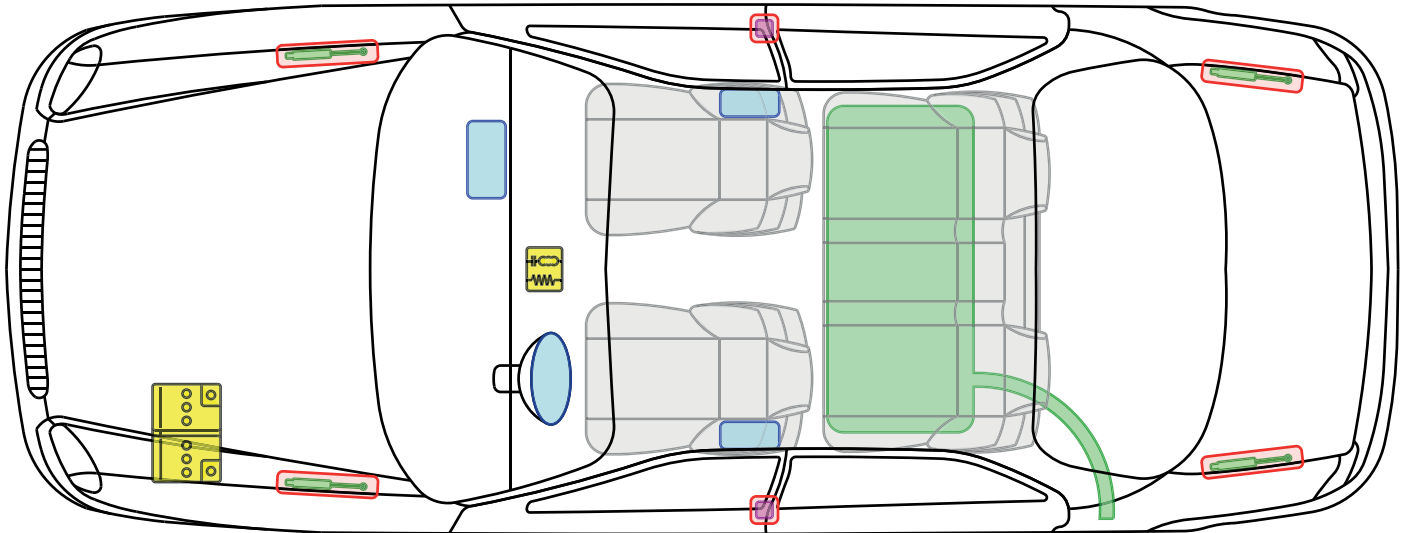

Legende

	Airbag		Karosserie- verstärkung		Steuergerät		Gastank
	Gas- generator		Überroll- schutz		12 V Batterie		Sicherheits- ventil
	Gurt- straffer		Gasdruck- dämpfer		Kraftstoff- tank		Fußgänger- schutzsystem

(Grand) Santa Fe

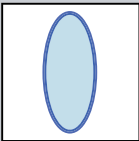
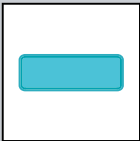

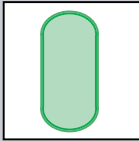
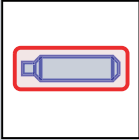
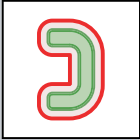
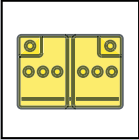

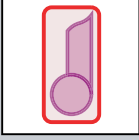
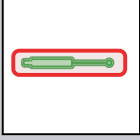
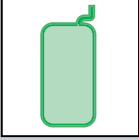
Legende

	Airbag		Karosserie- verstärkung		Steuergerät		Gastank
	Gas- generator		Überroll- schutz		12 V Batterie		Sicherheits- ventil
	Gurt- straffer		Gasdruck- dämpfer		Kraftstoff- tank		

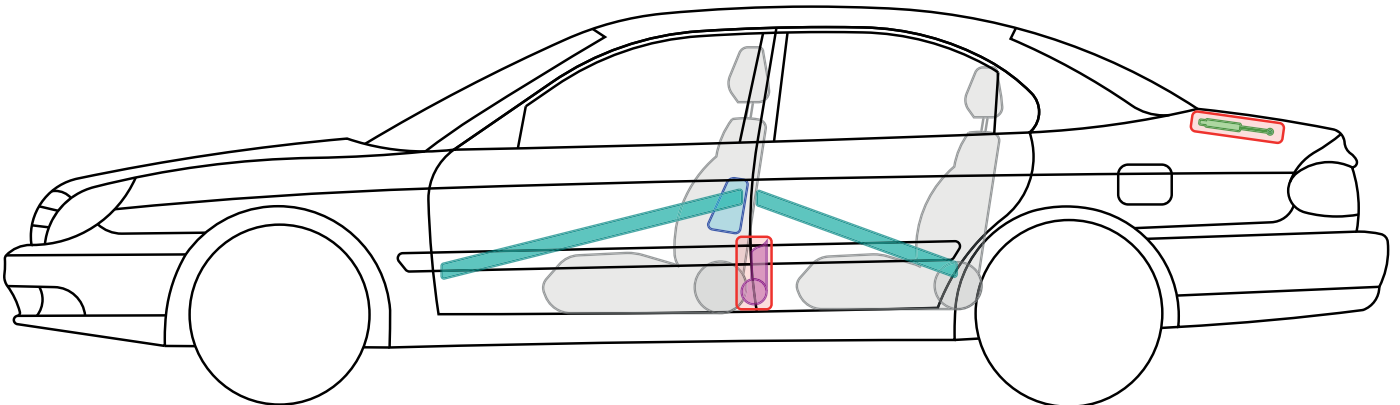
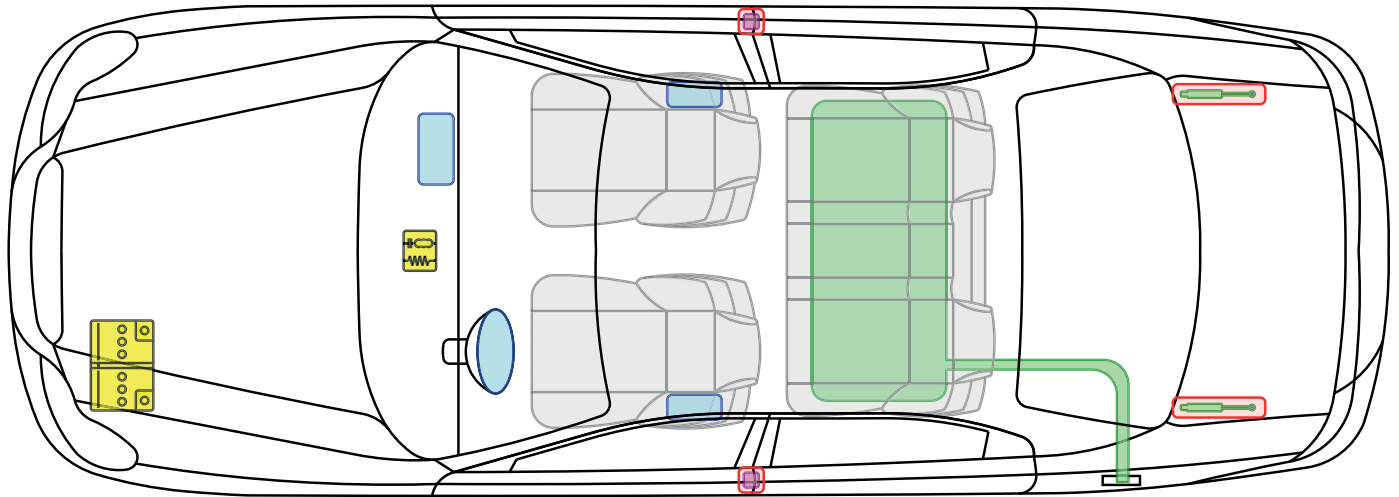
Sonata



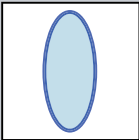
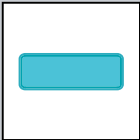
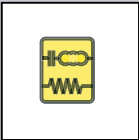
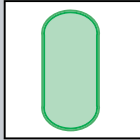
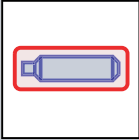
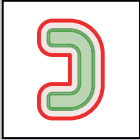
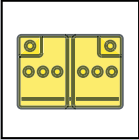

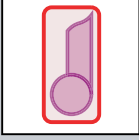
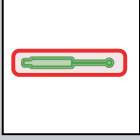
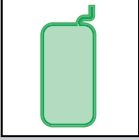
Legende

	Airbag		Karosserie- verstärkung		Steuergerät		Gastank
	Gas- generator		Überroll- schutz		12 V Batterie		Sicherheits- ventil
	Gurt- straffer		Gasdruck- dämpfer		Kraftstoff- tank		

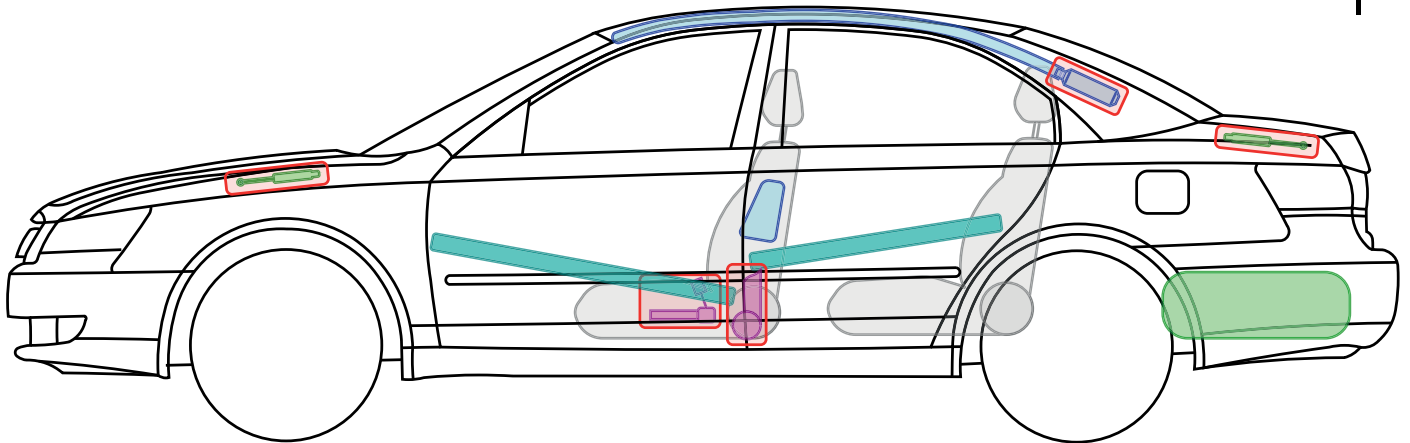
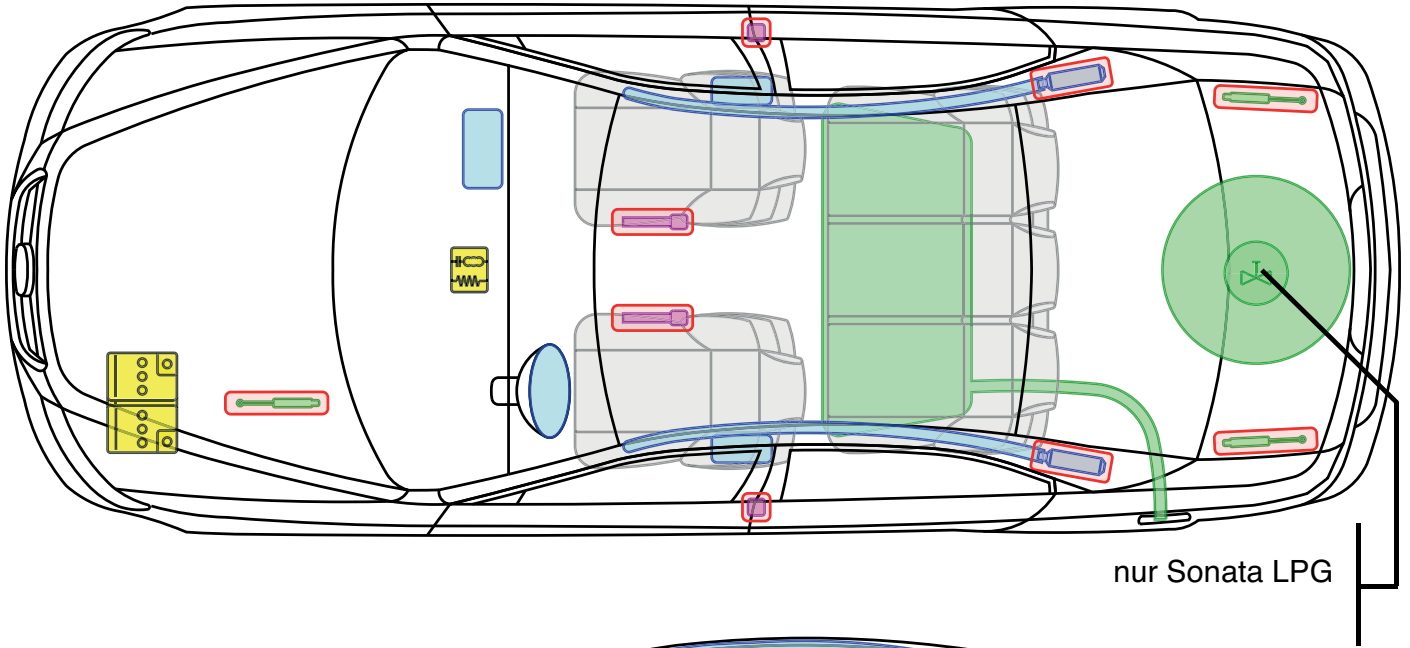
Sonata



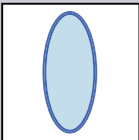
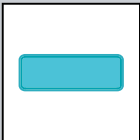

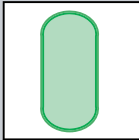
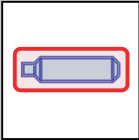
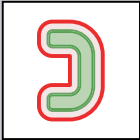
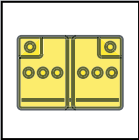
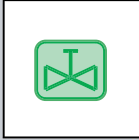
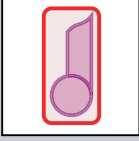
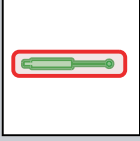
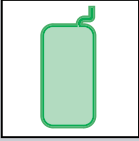

Legende

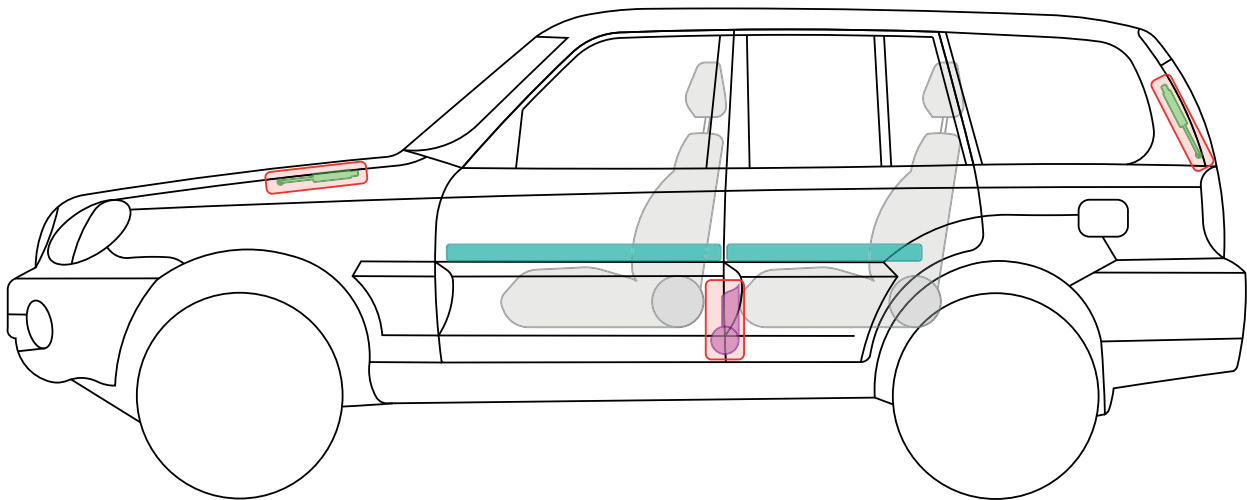
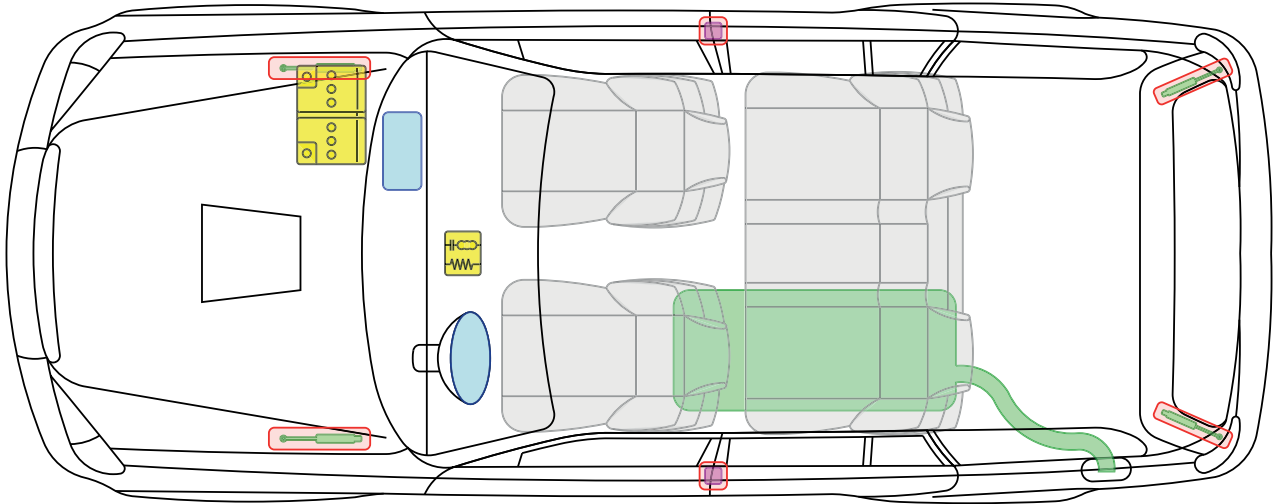
	Airbag		Karosserie- verstärkung		Steuergerät		Gastank
	Gas- generator		Überroll- schutz		12 V Batterie		Sicherheits- ventil
	Gurt- straffer		Gasdruck- dämpfer		Kraftstoff- tank		

Sonata

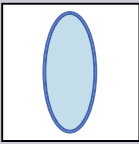
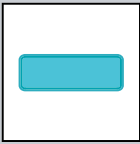

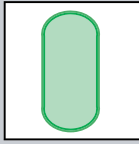
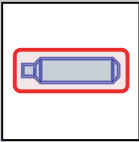
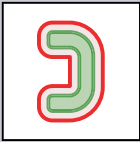
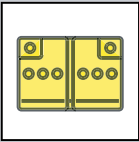
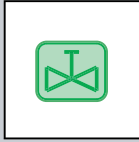
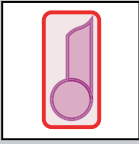
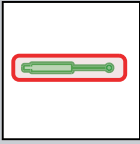

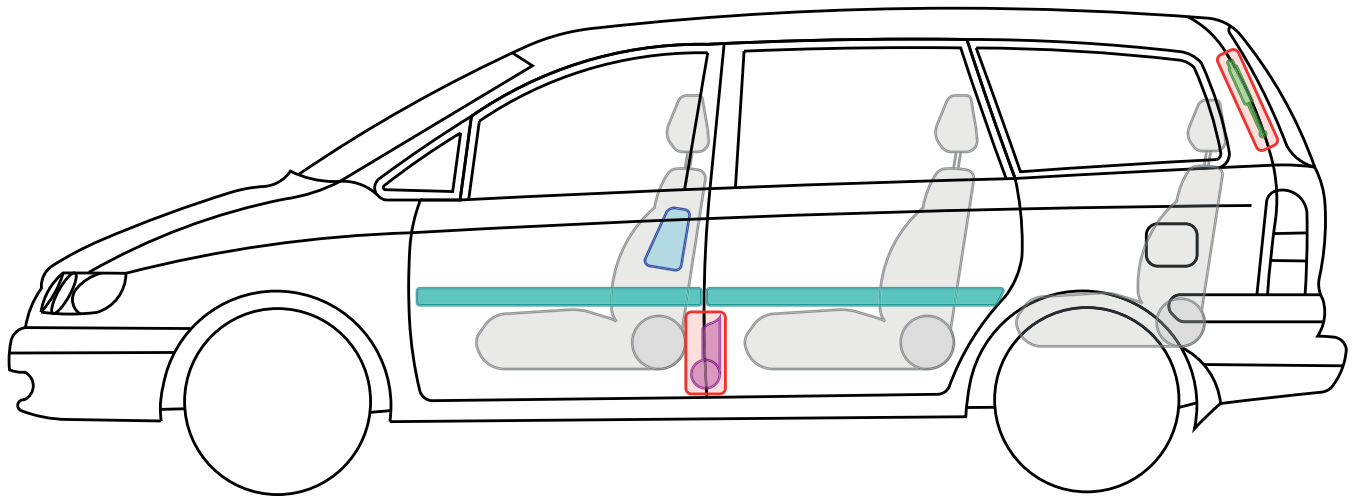
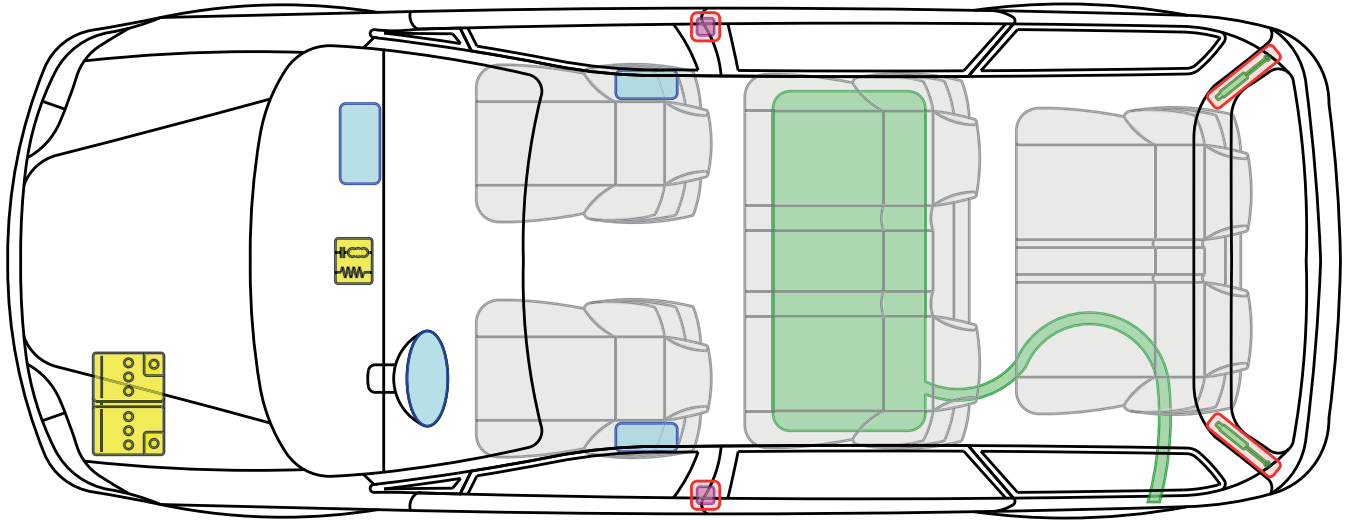

Legende

	Airbag		Karosserie- verstärkung		Steuergerät		Gastank
	Gas- generator		Überroll- schutz		12 V Batterie		Sicherheits- ventil
	Gurt- straffer		Gasdruck- dämpfer		Kraftstoff- tank		

Terracan

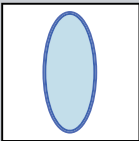
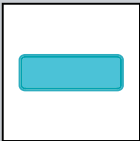

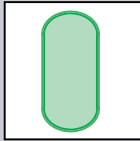
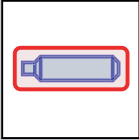
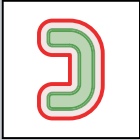
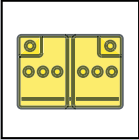
Legende

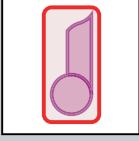
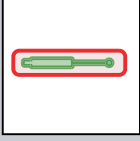
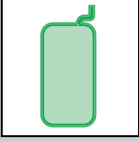
	Airbag		Karosserie- verstärkung		Steuergerät		Gastank
	Gas- generator		Überroll- schutz		12 V Batterie		Sicherheits- ventil
	Gurt- straffer		Gasdruck- dämpfer		Kraftstoff- tank		



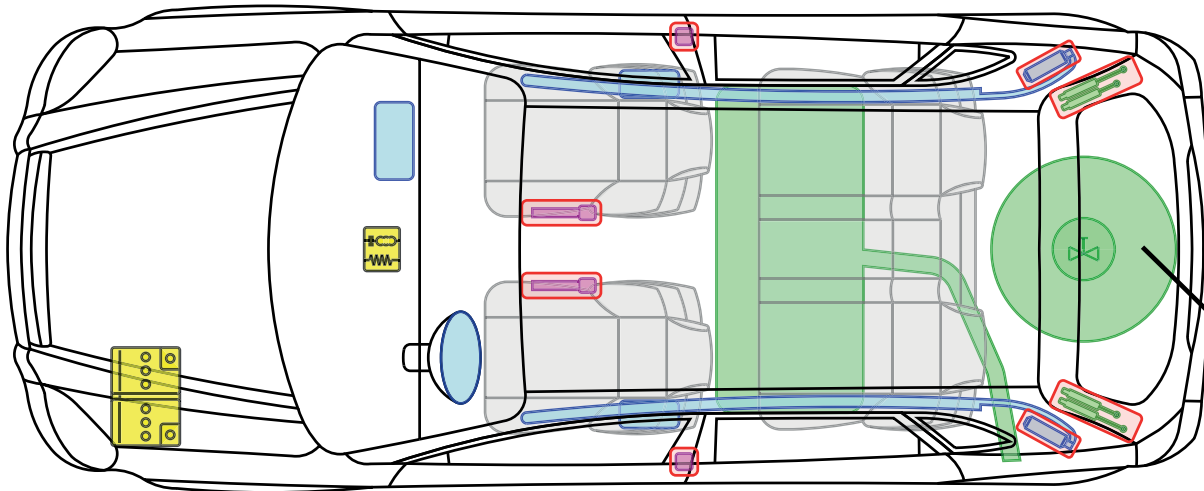

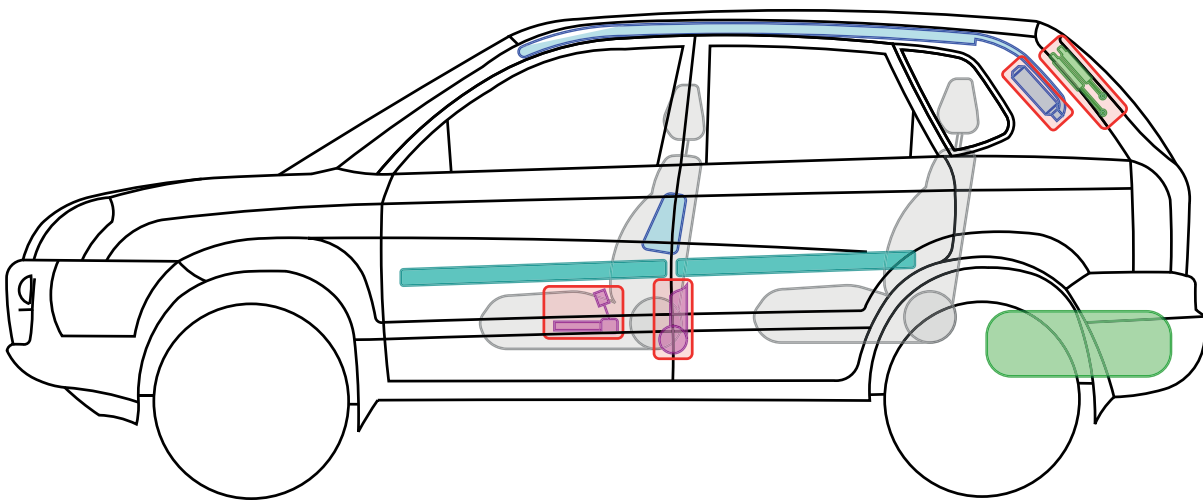

Trajet

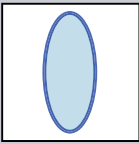
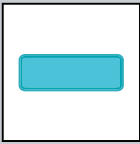

nur Tucson LPG

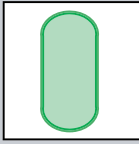
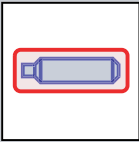
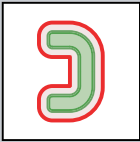
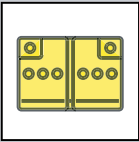

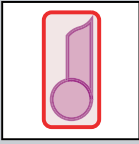
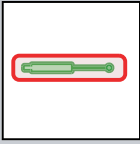

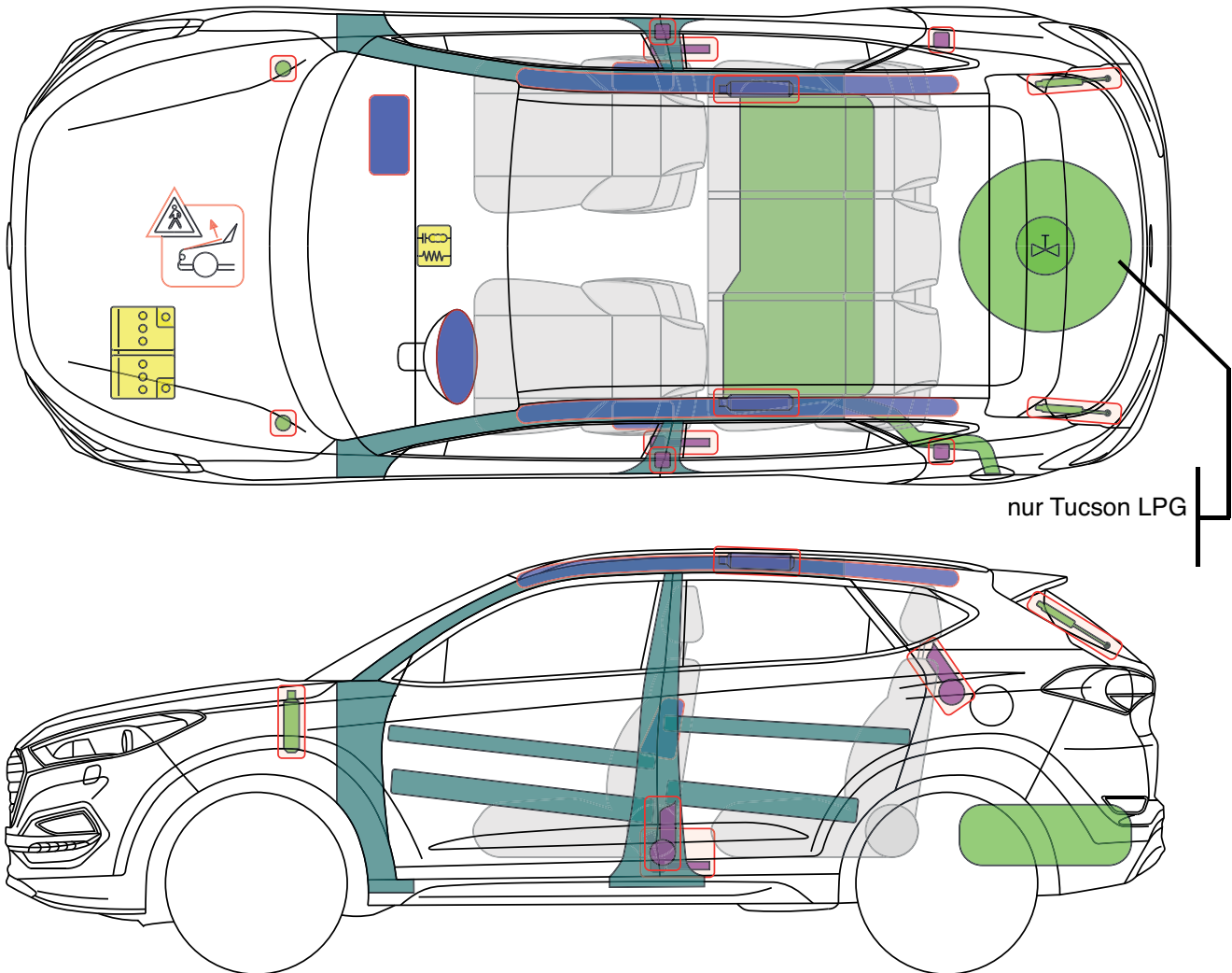

Legende

	Airbag		Karosserie- verstärkung		Steuergerät		Gastank
	Gas- generator		Überroll- schutz		12 V Batterie		Sicherheits- ventil
	Gurt- straffer		Gasdruck- dämpfer		Kraftstoff- tank		

Tucson

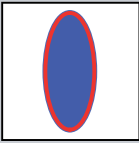
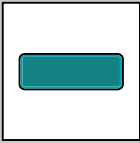
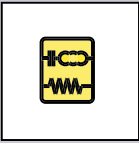
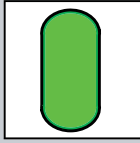
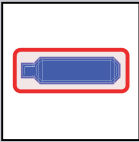

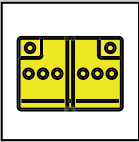
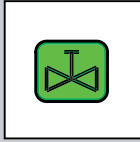
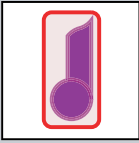
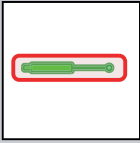



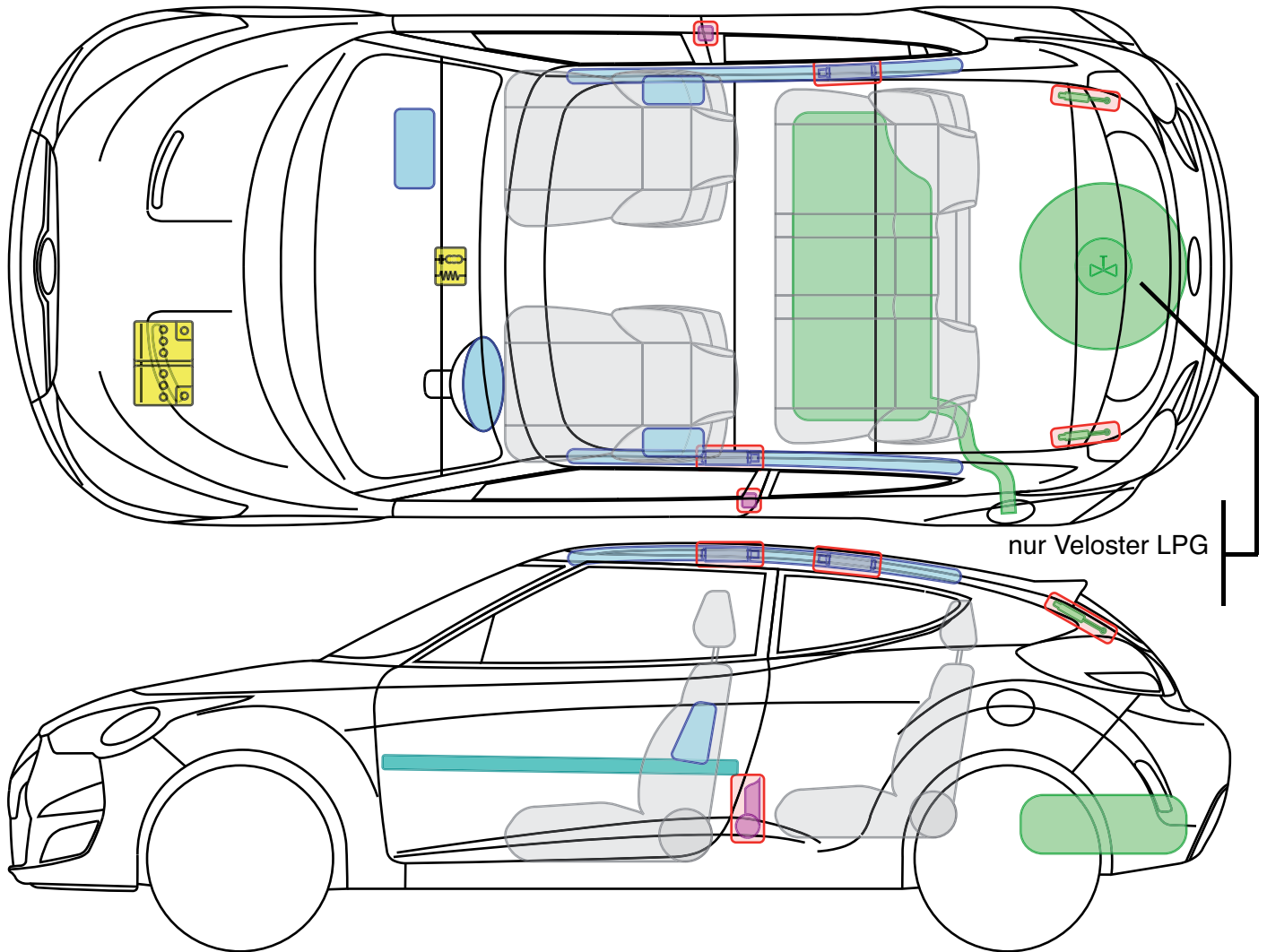

Legende

	Airbag		Karosserie- verstärkung		Steuergerät		Gastank
	Gas- generator		Überroll- schutz		12 V Batterie		Sicherheits- ventil
	Gurt- straffer		Gasdruck- dämpfer		Kraftstoff- tank		

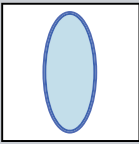
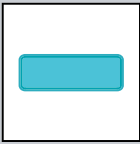
Tucson

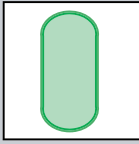
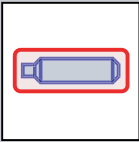
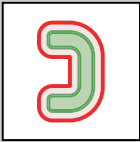
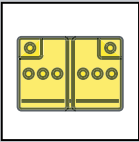

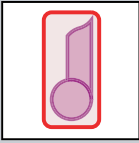
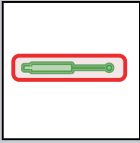

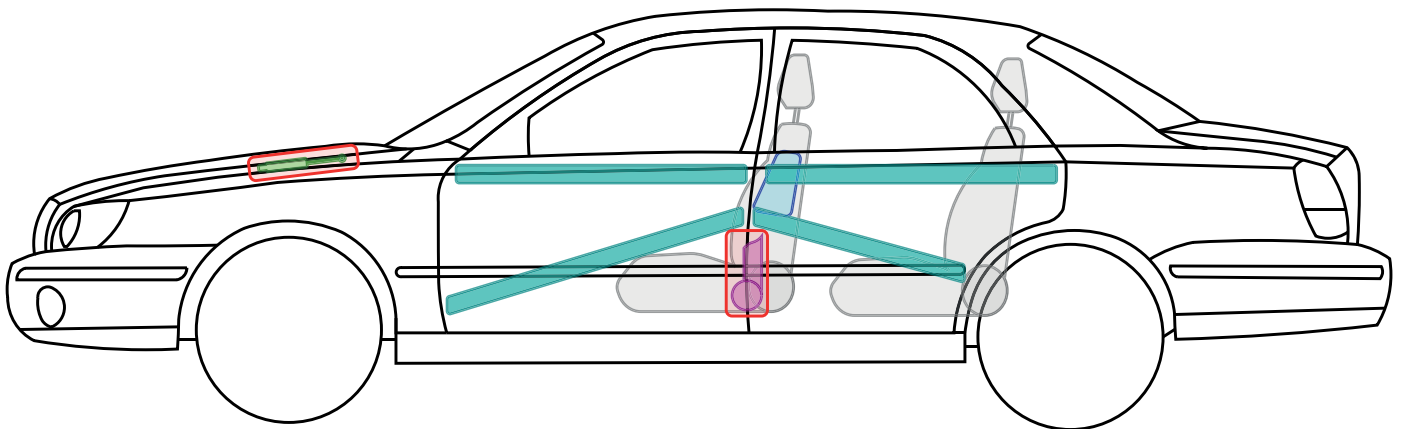
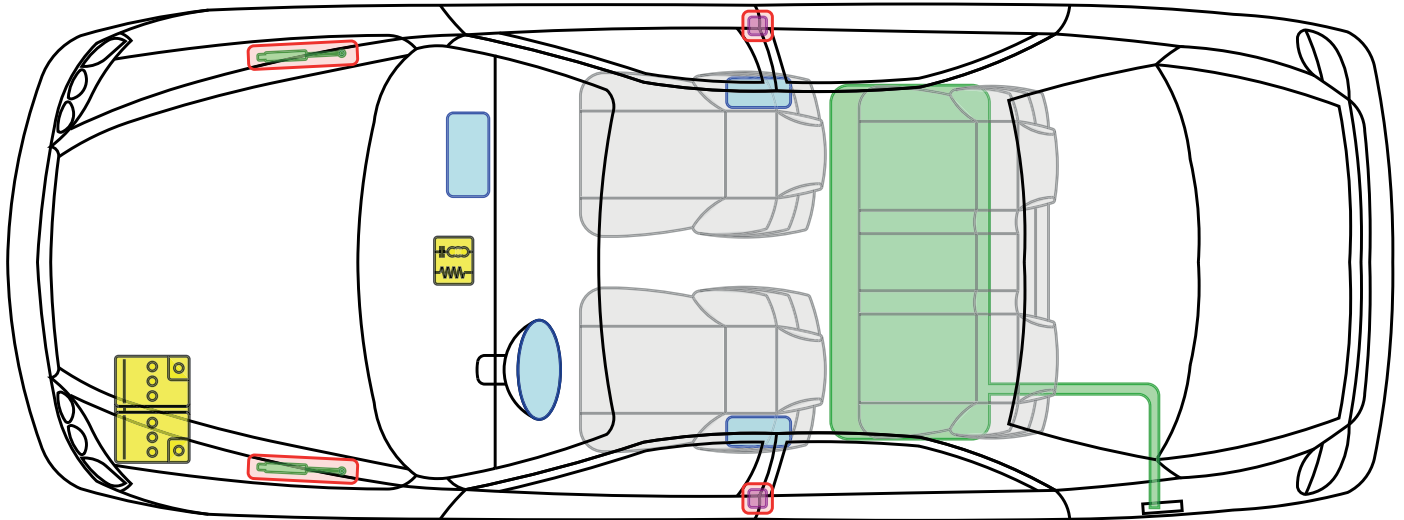

Legende

	Airbag		Karosserie- verstärkung		Steuergerät		Gastank
	Gas- generator		Überroll- schutz		12 V Batterie		Sicherheits- ventil
	Gurt- straffer		Gasdruck- dämpfer		Kraftstoff- tank		

Veloster

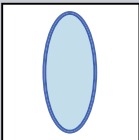
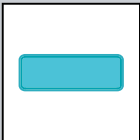

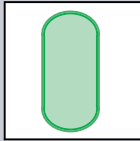
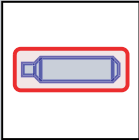
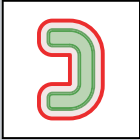
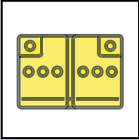
Legende

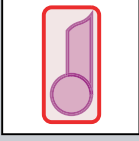
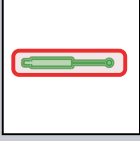
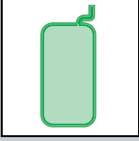
	Airbag		Karosserie- verstärkung		Steuergerät		Gastank
	Gas- generator		Überroll- schutz		12 V Batterie		Sicherheits- ventil
	Gurt- straffer		Gasdruck- dämpfer		Kraftstoff- tank		

XG